

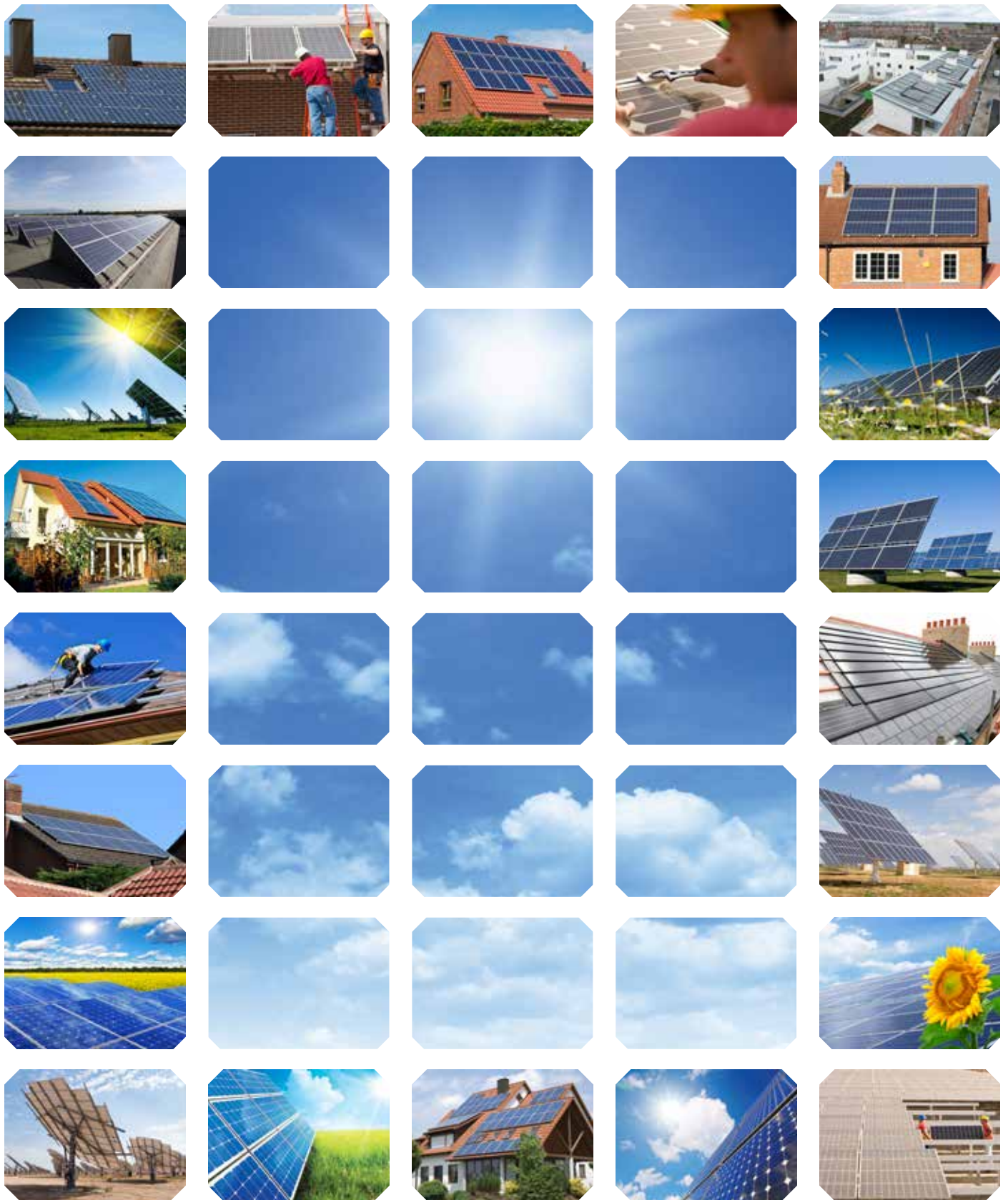

"Brighter Solutions"
**Solar
Product Range**



IMO is at the forefront of control component technology specifically developed for the renewable energy market and in particular solar energy. Whether meeting the demands of safe and efficient DC switching or delivering tracking solutions that help to maximise solar energy conversion rates, you can be sure that IMO products have been developed to meet the highest technical and commercial standards.



"Keeping Solar Safe"

Contents

	Page
IMO Solar Guide - Abbreviations	4
Introduction to PV Design	5
SI Range DC Isolators	12
Ordering Variations	13
Part Number Configuration	13
Switching Configurations	14
Technical Data	15
Dimensions	33
SIM Range DC Isolators	38
Ordering Variations	39
Part Number Configuration	39
Switching Configurations	40
Technical Data	41
Handle Options	48
Dimensions	49
Distribution/String Boxes	52
Enclosed AC Isolators	53
Solar Panel Rapid Shutdown	54
Solar Tracker & Measurement	56
Solar Relays	58
PV Rated DIN Rail Terminals	59

IMO Solar Guide - Abbreviations



AC	Alternating Current
DC	Direct Current
I_e	Rated Operational Current
IMO	IMO Precision Controls
I_{sc}	Short-Circuit Current
I_{th}	Thermal Current
MPPT	Maximum Power Point Tracking
PV	Photovoltaic
V_{oc}	Open-Circuit Voltage
References	
BS 7671	Requirements for Electrical Installations
IEC/EN 60364-7-712	Low-voltage electrical installations. Part 7-712: Requirements for special installations or locations. Photovoltaic (PV) power systems
IEC/EN 60529	Specification for degrees of protection provided by enclosures (IP code)
IEC/EN 60947-1 UL 60947-1	Low-voltage switchgear and controlgear. Part 1: General rules
IEC/EN 60947-3 UL 60947-3	Low-voltage switchgear and controlgear. Part 3: Switches, disconnectors, switch-disconnectors and fuse-combination units
UL 60947-4-1	Low-voltage switchgear and controlgear. Contactors and motor-starters. Electromechanical contactors and motor-starters
IEC/EN 61215	Crystalline silicon terrestrial photovoltaic (PV) modules – Design qualification and type approval
IEC/EN 61646	Thin-film terrestrial photovoltaic (PV) modules - Design qualification and type approval
Nema 250	Enclosures for Electrical Equipment (1000 Volts Maximum)
UL 94	Standard for Tests for Flammability of Plastic Materials for Parts in Devices and Appliances
UL 508	Industrial Control Equipment
UL 508i	Manual Disconnect Switches intended for use in Photovoltaic Systems
DTI/Pub URN 06/1972	Photovoltaics in Buildings, Guide to the installation of PV systems 2nd Edition
Guide to Installation of PV Systems – 3rd Edition	
Other Relevant References	
G83/1-1	Recommendations for Connection of Small-scale Embedded Generators (Up to 16A per Phase) in Parallel with Public Low-Voltage Distribution Networks
G59/2	Recommendations for the Connection of Generating Plant to the Distribution Systems of Licensed Distribution Network Operators
NFPA70 2017	National Electrical Code

Introduction to PV design

A Photovoltaic (PV) power system primarily converts sunlight directly into electricity using a photovoltaic cell array. The conversion of the solar radiation into electric current is carried out using the photoelectric effect found when some semiconductors that are suitably “doped” generate electricity when exposed to solar radiation.

As an individual PV-cell gives a relatively low output, a number of PV-cells are connected in series to supply higher voltages and connected in parallel in order to offer higher current capability. These cell arrays are referred to as PV-panels, and a number of interconnected panels are referred to as PV-strings. If there is a requirement for increased capacity then a larger system can be constructed whereby the PV-strings are connected in parallel to form a PV-array that gives a DC output current equivalent to the sum of all the PV-string outputs.

The main advantages of photovoltaic (PV) electricity generation are as follows:

- no fossil fuel usage and subsequent emission of pollution
- no nuclear fuel usage and disposal or storage of radioactive materials
- local distributed generation where needed
- installed system reliability and extended life
- reduced operating and maintenance costs
- ease of upgrading and replacement if necessary due to modularity of installation

When considering PV panels it is important to ensure that the units comply with all relevant standards for both electrical performance and for building requirements. It is recommended that, where possible, they comply with either IEC 61215 or IEC 61646, depending upon the structure of the cells. Once chosen the panels should be mounted in a location that maximises their exposure to sunlight for as long as possible and limits the possibility of shading, or future potential shading.

An inverter should be chosen to match the overall power capacity of the PV array, and like the arrays, it should operate as efficiently as possible. When considering the inverter, one using a Maximum Power Point Tracking (MPPT) system is preferential as this is a technique that grid connected inverters use to get the maximum possible power from one or more photovoltaic devices.

Where the PV installation is tied into the domestic grid system then the rules and procedures designated in G83 should be referred to and followed by a competent installer who is associated with a suitable accreditation scheme such as MCS.

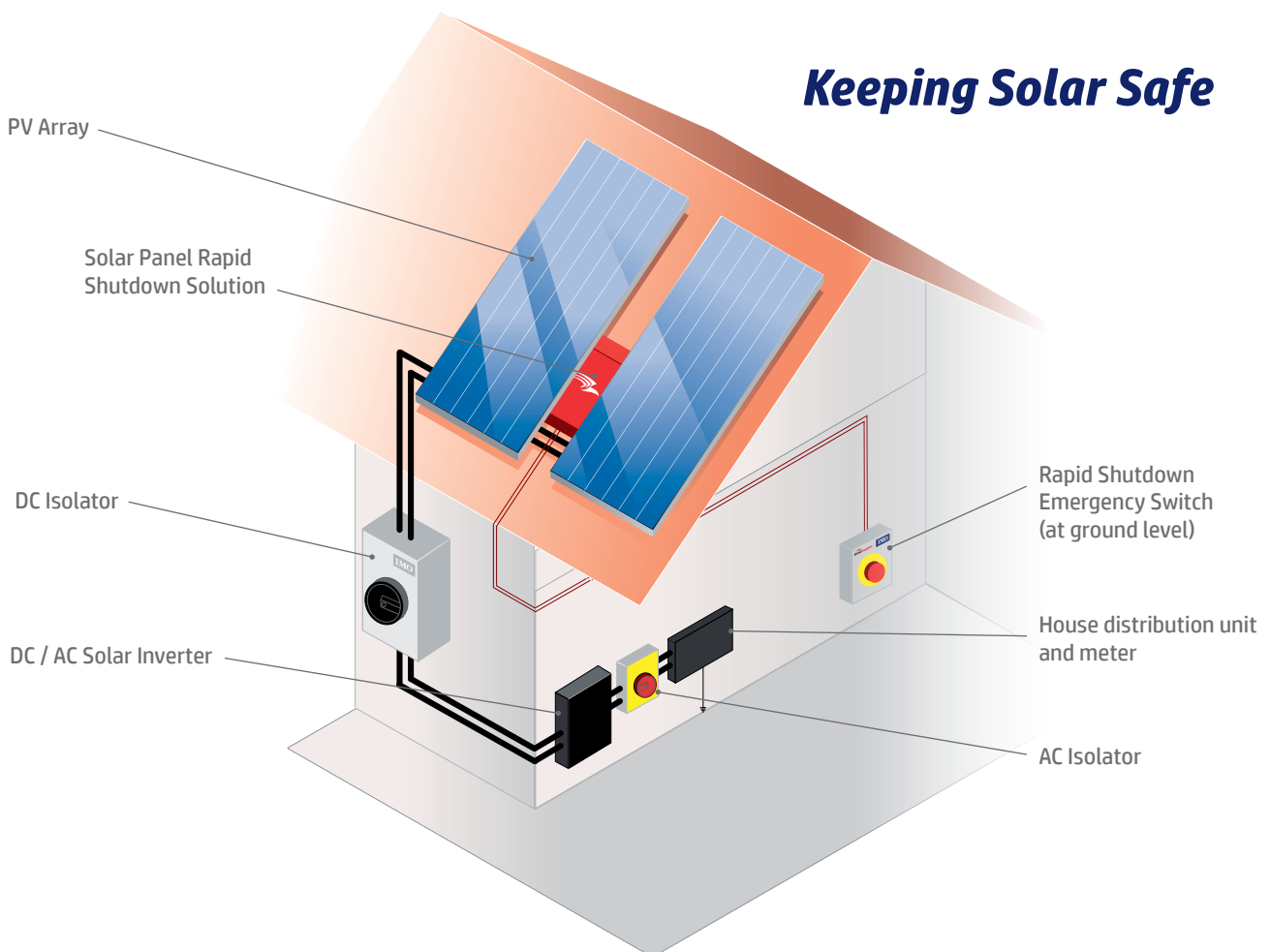

Utilisation Categories

Utilisation Categories as are covered in the European Standards EN 60947-1 & EN60947-3 and define an equipment's intended application. The list of both AC and DC categories for low-voltage switchgear and controlgear are stated in EN 60947-1 Annex A along with the relevant product standards.

Manufacturers of both switchgear and controlgear should include in their technical product data all the operational ratings for the utilisation categories for which a product is designed and as such this should remove the confusion for users and designers in their selection of the correct product.

If we consider PV installations where there are requirements for switchgear being used on the DC side then the system falls typically within two categories below (for which the relevant standard is EN 60947-3)

DC-21 Switching of resistive loads, including moderate overloads

DC-22 Switching of mixed resistive and inductive loads, including moderate overloads

DC-PV1 Switching of single PV string(s) without reverse and overcurrents

DC-PV2 Switching of several PV strings with reverse and overcurrents

Compliance to the EN60947-3 utilisation categories involves the products completing a number of tests, these include the "Making and Breaking Capacity" (section 7.2.4.1/D7.2.4.1) and "Operational Performance" (section 7.2.4.2/D7.2.4.2). Verification of the operational making and breaking capacities are stated by reference to the rated operational voltage and rated operational current according to Table 3 and Table D7 (see extracts below).

Test Conditions for Making & Breaking Capacities

Utilisation categories	Rated operational categories	Making			Breaking			Number of operating cycles
		I/I_e	U/U_e	L/R ms	I_c/I_e	U_c/U_e	L/R ms	
DC-21A - DC-21B	All values	1.5	1.05	1	1.5	1.05	1	5
DC-22B	All values	4	1.05	2.5	4	1.05	2.5	5
DC-PV1	All values	1.5	1.05	1	1.5	1.05	1	5
DC-PV2	All values	4	1.05	1	4	1.05	1	5

Test Conditions for Number of On Load Operating Cycles

Utilisation categories	Number of operating cycles per hour	Number of operating cycles					
		A categories			B categories		
		Without current	With current	Total	Without current	With current	Total
DC-21A/B & DC-22B	120	8,500	1,500	10,000	1,700	300	2,000
DC-PV1 & DC-PV2	120	9,700	300	10,000	-	-	-

Utilisation categories	Rated operational categories	Making			Breaking		
		I/I_e	U/U_e	L/R ms	I_c/I_e	U_c/U_e	L/R ms
DC-21A - DC-21B	All Values	1	1	1	1	1	1
DC-22B	All Values	1	1	2	1	1	2
DC-PV1	All Values	1	1	1	1	1	1
DC-PV2	All Values	1	1	1	1	1	1

I =making current I_c =breaking current I_e =rated operational current
 U =applied voltage U_e =rated operational voltage U_r =operational frequency or d.c recovery voltage

PV Installation Isolation

PV installations consist of the DC side, the Inverter and the AC side with isolation required for both the PV-array to the inverter and for the AC supply from the load, particularly where the system is connected to the Distributed Network, this is a stipulation in G83/1. In some instances the “Guide to Installation of PV Systems” allows inverter and DC string isolation to be provided by the same device, for example the PV plug and socket connectors, but this is only deemed suitable for smaller systems and the connectors must be labelled appropriately. Generally IMO would always recommend the use of a suitably rated DC isolator.

DC Isolator Selection

BS 7671 states that a method of isolation must be provided on the DC side of a PV installation and this can be provided by a switch-disconnector as classified under EN 60947-3 this is also covered by “Guide to the installation of PV systems”. The Guide also stipulates that the switch must isolate all live conductors (typically double pole to isolate PV array positive and negative conductors).

BS 7671 specifies that isolators that are in compliance with EN 60947-3 are appropriate for use in PV systems. The isolator rating must consider the maximum voltage and current of the PV string being switched and these parameters then adjusted in accordance with the safety factors stipulated in current standards. This should then be the minimum required rating of the isolator.



$$\text{Voltage} = N_s \times V_{oc} \times 1.15 \quad \text{Current} = N_p \times I_{sc} \times 1.25$$

N_s - Number of panels connected in series
 V_{oc} - Open-Circuit Voltage (from module manufacturer's data)

N_p - Number of strings connected in parallel
 I_{sc} - Short-Circuit Current (from module manufacturer's data)

The isolator should also be suitable for use in the appropriate application which in PV installations is normally considered to be either DC-21A, DC-21B, DC-22A or DC-22B. Normally isolation of the DC supply from the inverter would not be a regular occurrence and therefore generally ratings for DC-21B or DC-22B would, as a minimum, be necessary; although category A types (as previously covered in Utilisation Categories) would be advantageous due to their capability of a higher number of switching operations, and therefore a longer guaranteed life.

AC Isolator Selection

AC Isolators are used in both stand-alone grid or network distributed systems. If connected to the distributed network then G83/1 stipulates the PV system must be connected directly to an isolation switch that is wired so as to isolate both the live and neutral conductors, capable of being secured in the “OFF” position and in an accessible location within the installation. In a stand-alone system IMO recommend that a lockable OFF isolation switch is similarly used within the installation. BS 7671 specifies that isolators that are in compliance with EN 60947-3 are appropriate for use in PV systems.

Unlike a DC isolator that is required to switch both the positive and negative conductors, an AC isolator should be chosen with regards to the supply being single phase, which is typically found in domestic installations or three phase, which is typical for commercial or industrial installations. Ideally for single phase a 2pole isolator should be used to switch the live and neutral line (earth constantly connected) whilst a 4pole isolator would be used to switch the 3 voltage lines and neutral (earth constantly connected).

The isolator rating should be based on the inverter output which is normally specified per phase, that is line to neutral, and for example maybe shown as 20A at 230VAC; if this output is from a three phase unit then the AC isolator must be rated to for the line-to-line voltage which would typically be 415VAC.

With both AC and DC isolators the ambient temperature of the environment in which the switch is mounted must be considered as most industrial switches are nominally rated for use in 35°C. However, if the isolator is to be used in an area where solar activity is prevalent, thereby making more efficient use of the installation and greater yield, or in an enclosed space such as a loft or that of an inverter enclosure, then an isolator capable of handling the elevated temperatures should be selected.

All IMO Solar Isolators are capable of being installed in areas where high ambient temperatures of up to +45°C can be found. In installations of higher temperatures, our open style product can be used up to +65°C, however, you should ensure safe operating conditions and correct mounting of the product.

Why use an IMO DC Solar Isolator?

IMO Precision Controls offers a range of True DC Isolators specifically designed for use in Solar PV installations in accordance with EN 60364-7-712. The IMO design incorporates a user independent switching action so as the handle is moved it interacts with a spring mechanism which, upon reaching a set point, causes the contacts to “SNAP” over thereby ensuring a very fast break/make action. This mechanism means that the disconnection of the load circuits and suppression of the arc, produced by a constant DC load, is normally extinguished in 3ms using the specific pole suppression chambers incorporated within the design.

Many alternative solutions, particularly those based upon an AC isolator designs which use bridge contacts, have been modified and rated for DC operation. These types of product have a switching speed that is directly linked to operator speed therefore, slow operation of the handle results in slow contact separation of the contacts which can produce arcing times of 100ms or more. Also in these switches the contact surface is also the surface upon which arcs tend to form; therefore, any surface damage or sooting caused by the arcing is likely to have a detrimental effect on the isolator's contact resistance and its longevity.

The IMO Solar Isolator range is offered in a number of configurations all rated for installation and use as switch-disconnects and all with options allowing for "LOCKABLE OFF" operation. Although able to offer the industry standard two position 90° handle operation from LOCKABLE OFF-ON, IMO have also introduced a **SAFE-LOCK** patented handle that allows for three rotational positions relating to ON-OFF-LOCK. The facility offered by this design gives a LOCK position that is removed from the OFF setting ensuring the handle can be placed in its own unique position when locked, which is fully compliant with IEC 60947-1 section 8.2.5.2.1 for classification as an isolator or switch disconnect. When this design is used within the IMO enclosed Solar Isolators it ensures that engineering access can only be attained to the enclosure when the handle is in the OFF position; whilst the "LOCK" position ensures secure power isolation combined with non-access to the enclosure (when the isolator block is secured with supplied screws) and thereby significantly reducing the risks of tampering when maintenance/repair is carried out on equipment in-line after the isolator, **SAFE-LOCK**. Once any work has been undertaken the locking mechanism can then be removed and the isolator returned to its normal operational mode.



IMO Solar Isolators use a rotary "knife contact" mechanism so when the unit is operated the handle movement gives a double make/break per contact set. As DC load switching creates arcing the design is such that this only occurs on the corners of the switching parts meaning that the main contact is made on an area where no arcing has occurred. The rotary contact mechanism methodology used in the IMO Solar Isolators means that, when the isolator is operated, a self-cleaning action occurs on the arcing points and contact surfaces thereby producing good high vibration resistant contact integrity, with reduced contact resistance. This IMO contact system ensures that power loss per pole is kept as low as possible and consistent over the life of the product unlike conventional style isolators where entrapment of contaminants, and then subsequent compression on lateral operation, can lead to variable and increasing contact resistance and hence per pole losses.

As indicated in the section about **Utilisation Categories**, the IMO product is satisfactory for use in installations classified as either DC-PV1, DC-PV2, DC-21A, DC-21B or DC-22A, and so suitable for a high number of "off load" operations (without current) and also a high number of operating cycles "on load" (with current).



Unlike a number of DC isolators on the market, the IMO solar isolator is also polarity independent, which means that there is no requirement for specific directional wiring of the PV supply. A further advantage of the IMO contact mechanism is that, in the event of the supply to earth failure, the high short circuit current pulls the contacts together thereby giving a high short circuit withstand current of up to 2400A (product dependent). PV residential installations are typically 1000VDC however, IMO Solar Isolators already have the capability to operate up to 1500VDC.

In the move towards safer installations of PV systems, whether it be in a domestic or industrial environment, consideration has to often be given to the materials and the risk of fire hazard that they pose. Ratings referred to under the UL 94 category are deemed generally acceptable for compliance with this requirement as this cover tests for flammability of polymeric materials used for parts in devices and appliances. Although there are 12 flame classifications specified in UL 94, there are 6 which relate to materials commonly used in manufacturing enclosures, structural parts and insulators found in consumer electronic products. These are 5VA, 5VB, V-0, V-1, V-2 and HB.

IMO DC Isolator Approvals

Country	RoHS ✓ RoHS	USA, UL508i 	US, CAN, UL60947-1 	Europe CE 	CCC China 	IEC CB Europe 	ESV Australia
SI16/SIM16/SIME16	✓	✓	✓	✓	✓	✓	✓
SI25/SIM25/SIME25	✓	✓	✓	✓	✓	✓	✓
SI32/SIM32/SIME32	✓	✓	✓	✓	✓	✓	✓
SI38/SIM38/SIME38	✓	✓	✓	✓	✓	✓	✓
SI40/SI55/SI65	✓	✓	✓	✓	✓*	✓	✓

* Please note that the SI65 does not have CCC approval for China

It is because of this that the IMO Solar Isolator range is constructed of materials that significantly reduce the risk of a fire hazard and in particular our enclosed installation style products for which the main plastic enclosure is rated at UL 94V-0 and the handles are UL 94V-2 rated. The classification criteria for each of these ratings is found in of the UL 94 Table 8.1 (see extract below).

Criteria conditions	V-0	V-1	V-2
Afterflame time for each individual specimen t1 or t2	≤10s	≤10s	≤30s
Total afterflame time for any condition set (t1 plus t2 for the 5 specimens)	≤50s	≤250s	≤250s
Afterflame puts afterglow time for each individual specimen after the second flame application (t2+t3)	≤30s	≤60s	≤60s
Afterflame or afterglow of any specimen up to the holding clamp	No	No	No
Cotton indicator ignited by flaming particles or drops	No	No	Yes

The installation requirements and environments of PV systems can vary significantly and the IMO Solar Isolator has been designed such that it can offer a wide range of configurations depending upon the users’ requirement. Also the IMO Solar Isolator range includes models that, when mounted in accordance with their respective instructions and with the appropriate IMO handle, offer suitable protection up to IP66 (EN 60529) and NEMA 4X (Nema 250, UL508).

With the advent of more worldwide installations and the requirements laid down in many country’s national wiring publications for the use of DC switches in PV installations, the IMO Solar Isolators have also been assessed and tested under the latest UL standard UL508i which has been specifically written to cover the use of “Manual Disconnect Switches intended for use in Photovoltaic Systems”.

This UL508i standard specifically covers switches rated up to 1500 V that are intended for use in an ambient temperatures of -20°C to +50°C, and that are suitable for use on the load side of PV branch protection devices. In order to comply with this standard the IMO DC Isolators has to pass an overload test, at +50°C, of 50 cycles at 200% of rated current; followed by an endurance test of 6000 cycles (6 cycles/min) at rated load (Ith) and a further 4000 cycles with no current.

The IMO DC Isolator has successfully attained certification under the UL508i standard and as such is suitable for use as a disconnection method for the isolation of the output of DC PV array where it is to be connected to a DC/AC inverter.

Examples of Typical PV Installations

Single String System – 3kW Output Single Phase

Consider two potential configurations for a typical 3kW system which would supply 13A at 230VAC:

Inverter:	Input: 600VDC (V_{OC}), 16A (I_{DC}), 32A (I_{DCmax})	Output: 230VAC (V_{AC}), 13A (I_{AC}), 17.2A (I_{ACmax})
Solar Panel:	60V (V_{OC}), 8A (I_{SC})	No. of panels: 8
Calculation:	$V = 8 \times 60 \times 1.15 = 552V$ $I = 8 \times 1.25 = 10A$	

For this configuration, the IMO SI16-PEL64R-2 rated at 16A for 700VDC is suitable for the DC switch and the PE69-3020 rated at 20A is suitable for the AC switch.

Inverter:	Input: 750VDC (V_{OC}), 15A (I_{DC}), 28A (I_{DCmax})	Output: 230VAC (V_{AC}), 13A (I_{AC}), 16A (I_{ACmax})
Solar Panel:	60V (V_{OC}), 8A (I_{SC})	No. of panels: 10
Calculation:	$V = 10 \times 60 \times 1.15 = 895.62V$ $I = 8 \times 1.25 = 10A$	

For this configuration, the IMO SI25-PEL64R-2 would still be suitable as it is rated at 16A for 800VDC, however the IMO SI25-PEL64R-2 rated at 16A for 900VDC would allow for a greater margin of safety. The PE69-3020 rated at 20A is suitable for the AC switch.

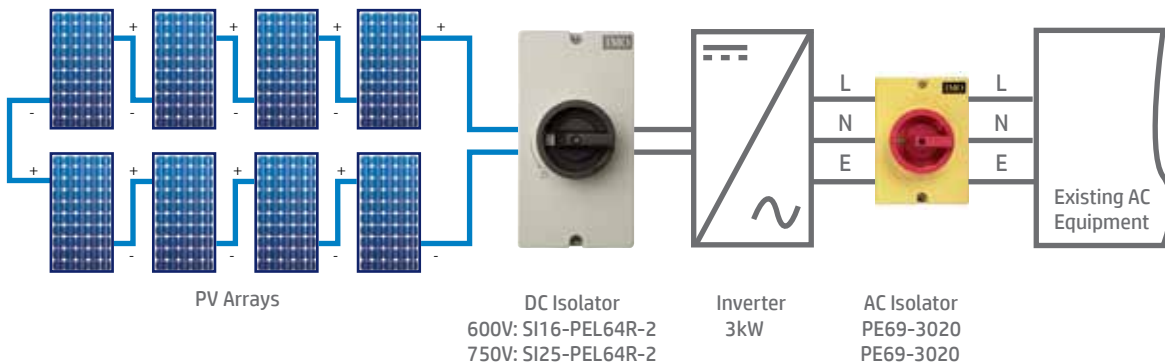

Dual String System – 5kW Output Single Phase

Consider a typical 5kW system which would supply 22A at 230VAC:

Inverter:	Input (per string): 600VDC (V_{OC}), 18A (I_{DC}), 36A ($I_{DC\ max}$)	Output: 230VAC (V_{AC}), 25A ($I_{AC\ max}$)
Solar Panel:	64.9V (V_{OC}), 6.46A (I_{SC}), 5.98A (I_{mpp}), 327Wp (P_{nom})	No. of panels: 8 per string
Calculation:	$V = 8 \times 64.9 \times 1.15 = 597.08V$ $I = 6.46 \times 1.25 = 8.08A$	

For this configuration, each string is to be switched at these levels so the IMO SI16-PEL64R-4 rated at 16A for 700VDC per string is suitable for the DC switch and the PE69-3025 rated at 25A is suitable for the AC switch.

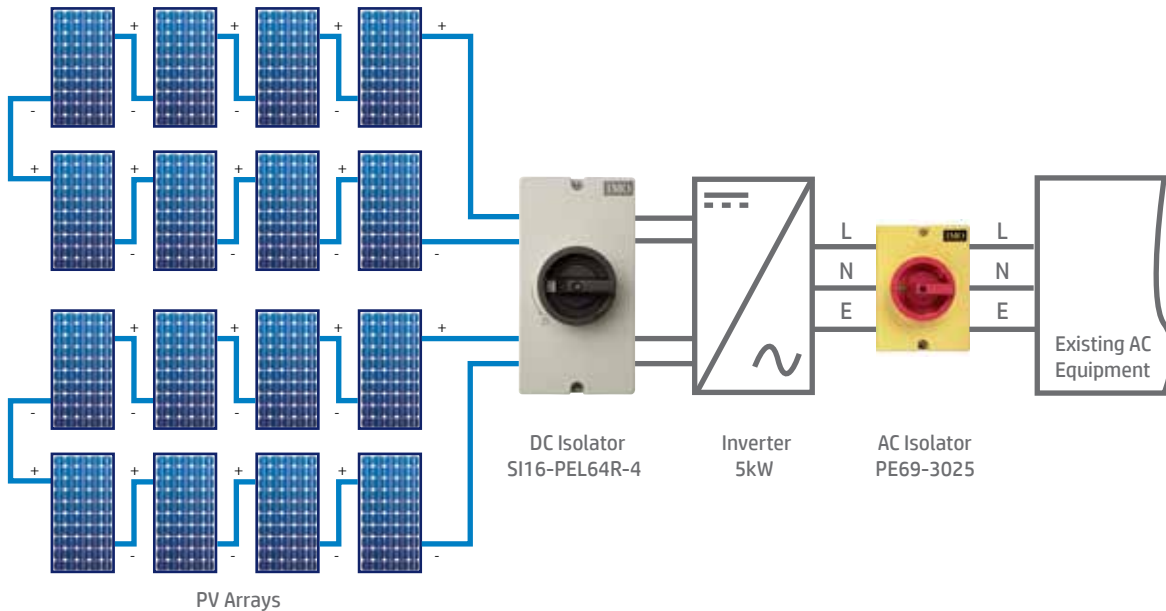

High Voltage Multi-string System – 12.5kW Output Three Phase

Inverter:	Input (per string): 900VDC (V_{OC}), 18A (I_{DC}), 36A ($I_{DC\ max}$)	Output: 4000VAC (V_{AC}), 20A ($I_{AC\ max}$)
Solar Panel:	64.9V (V_{OC}), 6.46A (I_{SC}), 5.98A (I_{mpp}), 327Wp (P_{nom})	No. of panels: 12 per string
Calculation:	$V = 12 \times 64.9 \times 1.15 = 895.62V$ $I = 6.46 \times 1.25 = 8.08A$	

For this system there are several options to consider. If each string is to be switched individually then the SI25-PEL64R-2 rated at 11A for 1000VDC is suitable for the DC switch. If there is a requirement to isolate the strings as pairs then the SI25-PEL64R-4 is suitable. If all strings are to be isolated using one DC isolator then the IMO SI25-PEL64R-8 is suitable. The PE69-3025 rated at 25A is suitable for the AC switch in each case.

Alternatively, if the requirement is to still have the capability of isolating each string individually whilst retaining a single housing unit, then an IMO distribution box populated with SI25-DBL-2 is suitable. These devices use the same switch block as the SI25-PEL64R-2 so have the same rating of 11A at 1000VDC.

This document is meant as a guide and IMO Precision Controls shall not be liable in any event whatsoever for any indirect, special or consequential damages, arising out of the use of the products covered by this document at any time or howsoever caused by the goods. IMO Precision Controls excludes any warranty, condition or statement, express or implied, statutory or otherwise, as to quality, merchantability, or fitness of the goods for any particular purpose.

Over 6 Million Installed Units **ZERO FAILURES**



In solar installation, the DC isolator is like a vehicle air-bag. You never know it really works until you need it. So it's good to know that the IMO SI has now surpassed six million installed units without a single recorded electrical failure.

Not surprising considering the product carries all the most important approvals including UL508i, IEC/EN 60947-1, UL 60947-1, IEC/EN 60947-3, UL 60947-4-1, CE, RCM and CCC. In fact, the IMO SI solar isolator has been tested by some of the most rigorous examiners and OEM manufacturers in the world, passing with flying colours every single time.

As ever, the SI range has a guaranteed arc suppression time of 3mS, in built arc cooling chambers, operator independent switching mechanism and Safe-Lock handle, making it one of the safest DC isolators available, no matter who uses it or how slowly they operate it.

Why take a risk on safety? Insist on TRUE DC, contact us for a quotation and see why the IMO SI TRUE DC Isolator is the sensible choice for the PV installer.

Keep Solar Safe



SI Solar Isolators

TRUE DC Isolators for PV Systems



- Market-leading design
- 2, 4, 6 & 8 pole versions available
- Max. rated current 85A@1000VDC (acc. to DC21B/DC-PV1 for SI55)
- Range of mounting options
- Guaranteed arc suppression (3ms typical)
- Operator independent switching mechanism
- Knife-edge contacts



Innovators in TRUE DC isolation

Since its launch, the SI range of TRUE DC isolators has set the benchmark safety standard for disconnection and isolation of the DC panel load in solar applications world-wide. Prior to the introduction of the SI series, AC modified isolators in multi-pole linked form were commonly used with all the performance and safety issues that such devices presented.

The SI TRUE DC range was specifically developed to meet the needs of the solar industry with full operator independent switching mechanism, a guaranteed 5ms maximum arc suppression time and long-life knife edge contacts. Arc chambers built-in to the unit keep the device cool under repeated operation and the full range of mounting options provide a solution for almost every application.

Adopted as the standard by many of the largest solar equipment designers and installers around the world, the SI Series continues to set the benchmark in solar safety.

Additional Resources

There is only so much you can illustrate in printed form, so we have included a QR code which will take you directly to the Featured Spotlight for TRUE DC isolators on the IMO website. Here you will be able to watch a couple of videos about solar safety and recommendations from the Institution of Engineering & Technology in conjunction with the BRE National Solar Centre, about raising the bar for quality in the solar PV industry.



Ordering Variations

Lever Handle Models

Panel Mount (4-screw) 64 x 64 Escutcheon Plate Lever Handle, IP66, NEMA 3R	Single Hole Mount (22.5mm) 48 x 48 Escutcheon Plate Lever Handle, IP66, NEMA 4X	Base Mount (door coupling) 64 x 64 Escutcheon Plate Lever Handle, IP66, NEMA 4X	Modular Switch Lever Handle, IP40, Open Type
SI**PM64*	SI**SHM*	SI**BMD64*	SI**DB*

Lever Handle Models with Lockable OFF

Panel Mount (4-screw) 64 x 64 Escutcheon Plate Lockable Lever Handle, IP66, NEMA 3R	Single Hole Mount (22.5mm) 48 x 48 Escutcheon Plate Lockable Lever Handle, IP66, NEMA 4X	Base Mount (door coupling) 64 x 64 Escutcheon Plate Lockable Lever Handle, IP66, NEMA 4X	Modular Switch Lockable Lever Handle, IP40, Open Type
SI**PML64*	SI**SHML*	SI**BMDCL64*	SI**DBL*

Rotary Handle Models with Lockable OFF

Panel Mount (4-screw) 64 x 64 Lockable Rotary Handle, IP66, NEMA 3R	Base Mount (door coupling) 64 x 64 Lockable Rotary Handle, IP66, NEMA 4X	Enclosed Version Lockable Rotary Handle, IP67, NEMA 4X
SI**PM64R*	SI**BMD64R*	SI**PEL64R*

NOTE:

For description of each mounting mechanism please refer to pages 27 - 30.
IP ratings are for front panel and enclosed.

Part Number Configuration

SI		16	-	PM64R	-	2
Series	SI DC Solar Isolator	SI				Number of Poles (see Switching Configurations on p.5)
Switch Rating	16 Amp 16	25 Amp 25	32 Amp 32	38 Amp 38	40 Amp 40	2 2-Pole
						2H 2-Pole 4 Parallel Poles
						4 4-Pole
						4S 2-Pole 4 Poles in Series (Input Top, Output bottom)
						4T 2-Pole 4 Poles in Series (Input & Output bottom)
						4B 2-Pole 4 Poles in Series (Input & Output top)
						6 6-Pole
						3H 2-Pole 6 Parallel Poles
						8 8-Pole
						4H 2-Pole 8 Parallel Poles
Mounting Type	Panel Mount (4-screw), 64 x 64 Escutcheon Plate, Lever Handle				PM64	
	Panel Mount (4-screw), 64 x 64 Escutcheon Plate, Lockable Lever Handle				PML64	
	Panel Mount (4-screw), 64 x 64 Lockable Rotary Handle				PM64R	
	Single Hole (22.5mm) Mount, 48 x 48 Escutcheon Plate, Lever Handle				SHM	
	Single Hole (22.5mm) Mount, 48 x 48 Escutcheon Plate, Lockable Lever Handle				SHML	
	Base Mount (DIN Rail), 64 x 64 Escutcheon Plate, Lever Handle				BMD64	Base Mount (DIN Rail), 64 x 64 Lockable Rotary Handle BMD64R
	Base Mount (DIN Rail), 64 x 64 Escutcheon Plate, Lockable Lever Handle				BMDCL64	Modular Switch, Lever Handle DB
						Modular Switch, Lockable Lever Handle DBL
						Enclosed Version, Lockable Rotary Handle PEL64R

Switching Configurations

Type	2-pole	2-pole 4 parallel poles	4-pole	4 poles in series Input on top Output bottom	4 poles in series Input and Output bottom	4 poles in series Input and Output on top
SI16	2	2H	4	4S	4T	4B
SI25	2	2H	4	4S	4T	4B
SI32	2	2H	4	4S	4T	4B
SI38	2	2H	4	4S	4T	4B
SI40	2	2H	4	4S	4T	4B
SI55	2	2H	4	4S	4T	4B
SI65	2	2H	4	4S	4T	4B
Contact Wiring Diagram						
Switching Example						

Type	6-pole	2-pole 6 parallel poles	8-pole	2-pole 8 parallel poles
SI16	6	3H	8	4H
SI25	6	3H	8	4H
SI32	6	3H	8	4H
SI38	6	3H	8	4H
SI40	6	3H	8	4H
SI55	6	3H	8	4H
SI65	6	3H	8	4H
Contacts Wiring Diagram				
Switching example				

Insulated Jumper for series and parallel switching of contacts

Type	SI16	SI25	SI32	SI38	SI40	SI55	SI65	
4T / 4B / 4S		2x SIV-B1-1N		2x SIV-B1-2N		2x SIV-B2-2N		
2H		4x SIV-B1-1N				4x SIV-B2-1N		
4H		8x SIV-B1-1N, 2x SIV-B1-2N			8x SIV-B2-1N, 2x SIV-B2-2N			

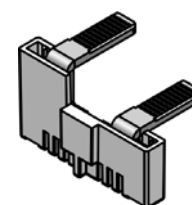



SIV-B1-1N

WARNING: Verify that all connections (including bridging link connections) are suitable for the rated current, prepared to ensure only conductive parts are clamped and tightened to the manufacturer's required torque before energisation.

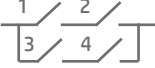
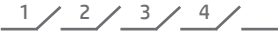
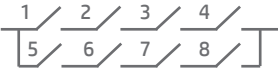
Technical Data for DC according to IEC 60947-3



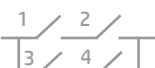



Type		DC-PV1								DC22B			
		500V	600V	700V	800V	900V	1000V	1200V	1500V	500V	600V	800V	1000V
2 poles in series 2 	SI16	16A	16A	16A	16A	16A	10A	7A	3A	7A	5.5A	2A	1A
	SI25	25A	25A	25A	20A	17A	11.5A	8.5A	5A	8A	6A	2.5A	1.5A
	SI32	32A	32A	32A	23A	20A	13A	10A	6A	9A	6.5A	3A	2A
	SI38	45A	45A	36A	30A	25A	20A	10A	6A				
	SI40	48A	48A	37A	35A	31A	29A	11A	7.5A				
	SI55	55A	55A	55A	55A	43A	36A	17A	10A				
	SI65	65A	65A	65A	65A	55A	40A	17A	10A				
2 poles in series + 2 parallel 2H 	SI16	29A	29A	22A	17A	16A	10A	7A	3A				
	SI25	45A	45A	27A	20A	17A	11.5A	8.5A	5A				
	SI32	58A	55A	32A	23A	20A	13A	10A	6A				
	SI38	65A	58A	36A	30A	25A	20A	10A	6A				
	SI40	72A	68A	49A	42A	31A	29A	11A	8A				
	SI55	85A	85A	77A	63A	43A	36A	17A	10A				
	SI65	85A	85A	80A	65A	55A	40A	17A	10A				
4 poles in series 4S, 4B, 4T 	SI16	16A	16A	16A	16A	16A	16A	16A	16A	16A	16A	11.5A	8A
	SI25	25A	25A	25A	25A	25A	25A	25A	25A	25A	25A	12A	9A
	SI32	32A	32A	32A	32A	32A	32A	32A	32A	32A	32A	12.5A	10A
	SI38	45A	45A	45A	45A	45A	38A	32A	32A				
	SI40	48A	48A	48A	48A	48A	40A	40A	40A				
	SI55	55A	55A	55A	55A	55A	55A	55A	55A				
	SI65	65A	65A	65A	65A	65A	65A	65A	65A				
4 poles in series + 2 parallel 4H 	SI16	29A	29A	29A	29A	29A	29A	29A	20A				
	SI25	45A	45A	45A	45A	45A	45A	33A	26A				
	SI32	58A	58A	58A	58A	58A	58A	50A	32A				
	SI38	65A	65A	65A	65A	65A	65A	50A	32A				
	SI40	72A	72A	72A	72A	72A	72A	56A	42A				
	SI55	85A	85A	85A	85A	85A	85A	65A	55A				
	SI65	85A	85A	85A	85A	85A	85A	65A	55A				

Technical Data for DC according to UL508i

Type		UL508i						
		350V	500V	600V	700V	800V	900V	1000V
2 poles in series 2 	SI16	16A	16A	16A				
	SI25	25A	25A	25A				
	SI32	32A	32A	32A				
	SI38	45A	45A	45A				
	SI40	48A	48A	48A	32A	26A	20A	16A
	SI55	55A	55A	55A	46A	37A	28A	20A
	SI65	65A	65A	65A	50A	40A	32A	25A
2 poles in series + 2 parallel 2H 	SI16	29A	29A	21A				
	SI25	45A	41A	30A				
	SI32	58A	43A	33A				
	SI38	58A	45A	36A				
	SI40	72A	53A	42A	35A	30A	26A	22A
	SI55	85A	66A	55A	47A	40A	32A	25A
	SI65	85A	73A	65A	50A	40A	32A	23A
4 poles in series 4S, 4H, 4T 	SI16	16A	16A	16A				
	SI25	25A	25A	25A				
	SI32	32A	32A	32A				
	SI38	45A	45A	36A				
	SI40	48A	48A	40A	40A	40A	40A	40A
	SI55	55A	55A	55A	55A	55A	55A	55A
	SI65	65A	65A	65A	65A	65A	65A	65A
4 poles in series + 2 parallel 4H 	SI16	29A	29A	29A				
	SI25	45A	45A	45A				
	SI32	58A	58A	50A				
	SI38	58A	58A	50A				
	SI40	80A	71A	65A	58A	51A	45A	42A
	SI55	85A	85A	85A	76A	71A	67A	64A
	SI65	85A	85A	85A	85A	76A	73A	70A

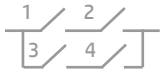
Technical Data

Data according to IEC 60947-3, VDE 0660, GB14048.3





Main Contacts		Type	SI16	SI25	SI32	SI38	SI40	SI55							
Rated thermal current I_{the}		A	16	25	32	45	48	55							
Rated insulation voltage $U_i^{1)}$		V	1000	1000	1000	1000	1500	1500							
Rated insulation voltage $U_i^{2)}$		V	1500	1500	1500	1500	1500	1500							
Distance of contacts (per pole)		mm	8	8	8	8	8	8							
Rated operational current I_e															
DC21A & DC21B	1 pole 1 	300V	A	16	23	27	27	40	55						
		400V	A	12	14	14	22	16	25	16	25	30	33	40	44
		500V	A	9	10	11	17	13	20	13	20	19	24	25	32
		600V	A	6	7	8	12	10	15	10	15	15	19	20	25
		700V	A	4.5	5	6		7.5		7.5		10	12	15	18
		800V	A	3		4		5		5		8	10	10	13
		900V	A	2.5	3	3		4		4		6	8	8	10
		1000V	A	1.5	2	2		2.5	3	2.5	3	4	5	6	8
		DC21B	2 poles in series 2 	500V	A	16	25	32		45	48		55		
				600V	A	16	25	32		45	48		55		
700V	A			16	23	25	27	32		36	35	37	55		
800V	A			16	16	20		23		30	35		45	55	
900V	A			13	16	16	17		20		25	25	31	35	43
1000V	A			9	10	11	11.5	13		20	25	29		36	
1200V	A			6	7	8	8.5	10			10	11	15	17	
1500V	A			3		4	5	5	6		6	6	7.5	7.5	10
2 poles in series + 2 poles parallel 2H 	500V			A	29	45	58			65	72		85		
	600V			A	29	45	50	55			64	68	80	85	
	700V			A	16	22	23	27	27	32		35	49	55	77
	800V			A	16	17	20		23		30	35	42	45	63
	900V			A	13	16	16	17		20		25	31	35	43
	1000V			A	9	10	11	11.5	13		20	23	29	25	36
	1200V			A	6	7	8	8.5	10			10	11	15	17
	1500V	A	3		4	5	5	6		6	6	7.5	7.5	10	
	3 poles in series + 2 poles parallel 3H 	500V	A	29	45	58				72		85			
		600V	A	29	45	50	58			72		85			
700V		A	29	38	43	45	55			72		85			
800V		A	29	38	40		51			68		85			
900V		A	29		38		47			62		78			
1000V		A	29		38		45			58		70			
1200V		A	12		14	25	16	28							
1500V		A	9		11	14	13	20							
4 poles in series 4S, 4B, 4T 		500V	A	16	25	32			45	48		55			
		600V	A	16	25	32			45	48		55			
	700V	A	16	25	32				40		55				
	800V	A	16	25	32				40		55				
	900V	A	16	25	32				40		55				
	1000V	A	16	25	32			38	40		55				
	1200V	A	16	25	32				40		55				
	1500V	A	16	20	25	23	32		32	30	40	40	55		
	4 poles in series + 2 poles parallel 4H 	500V	A	29	45	58			65	72		85			
		600V	A	29	45	58				72		85			
700V		A	29	45		58			72		85				
800V		A	29	45		58			72		85				
900V		A	29	45		58			72		85				
1000V		A	29		45	58		65		72		85			
1200V		A	29		45	50		50		56		65			
1500V		A	16		20	26	23	32		32	42		55		
Rated operational current I_e															
AC21B		2, 4	U_e max. 440V	A	16	25	32	45	48	55					
	2H	U_e max. 440V	A	29	45	58	72	85							

1) Suitable at overvoltage category I to III, pollution degree 3 (standard-industry): $U_{imp} = 8kV$.

2) Suitable at overvoltage category I to III, pollution degree 2 (min.IP55): $U_{imp} = 8kV$.



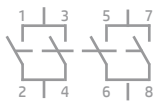
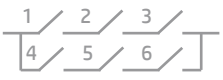

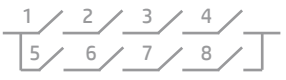
Technical Data continued

Data according to IEC 60947-3, VDE 0660, GB14048.3

Main Contacts	Type	SI16	SI25	SI32	SI38	SI40	SI55	SI65		
Rated operational current I_n 1 pole 1 	300V	A	16	23	27	27	40	55	65	
	400V	A	14	22	25	25	33	44	50	
	500V	A	10	17	20	20	24	32	40	
	600V	A	7	12	15	15	19	25	30	
	700V	A	5	6	7.5	7.5	12	18	21	
	800V	A	3	4	5	5	10	13	15	
	900V	A	3	3	4	4	8	10	10	
	1000V	A	2	2	3	3	5	8	8	
	2 poles in series 2 	500V	A	16	25	32	45	48	55	65
		600V	A	16	25	32	45	48	55	65
700V		A	16	25	32	36	37	55	65	
800V		A	16	20	23	30	35	55	65	
900V		A	16	17	20	25	31	43	55	
1000V		A	10	11.5	13	20	29	36	40	
1100V		A	8	10	11.5	-	19	25	-	
1200V		A	7	8.5	10	10	11	17	17	
1300V		A	6	7	8	-	10	14	-	
1400V		A	5	6	7	-	9	12	-	
1500V		A	3	5	6	6	8	10	10	
2 poles in series + 2 poles parallel 2H 		500V	A	29	45	58	65	72	85	85
		600V	A	29	45	55	58	68	85	85
		700V	A	22	27	32	36	49	77	80
		800V	A	17	20	23	30	42	63	65
	900V	A	16	17	20	25	31	43	55	
	1000V	A	10	11.5	13	20	29	36	40	
	1100V	A	8	10	11.5	-	19	25	-	
	1200V	A	7	8.5	10	10	11	17	17	
	1300V	A	6	7	8	-	10	14	-	
	1400V	A	5	6	7	-	9	12	-	
	1500V	A	3	5	6	6	8	10	10	
	3 poles in series + 2 poles parallel 3H 	500V	A	29	45	58	-	72	85	-
		600V	A	29	45	58	-	72	85	-
		700V	A	29	43	55	-	72	85	-
		800V	A	29	40	51	-	68	85	-
900V		A	29	38	47	-	62	78	-	
1000V		A	29	38	45	-	58	70	-	
1100V		A	19	27	37	-	-	-	-	
1200V		A	17	25	28	-	-	-	-	
1300V		A	15	21	25	-	-	-	-	
1400V		A	12	18	22	-	-	-	-	
1500V		A	10	14	20	-	-	-	-	
4 poles in series 4S, 4B, 4T 		500V	A	16	25	32	45	48	55	65
		600V	A	16	25	32	45	48	55	65
		700V	A	16	25	32	45	48	55	65
		800V	A	16	25	32	45	48	55	65
	900V	A	16	25	32	45	48	55	65	
	1000V	A	16	25	32	38	40	55	65	
	1100V	A	16	25	32	-	40	55	65	
	1200V	A	16	25	32	32	40	55	65	
	1300V	A	16	25	32	-	40	55	65	
	1400V	A	16	25	32	-	40	55	65	
	1500V	A	16	25	32	32	40	55	65	
	4 poles in series + 2 poles parallel 4H 	500V	A	29	45	58	65	72	85	85
		600V	A	29	45	58	65	72	85	85
		700V	A	29	45	58	65	72	85	85
		800V	A	29	45	58	65	72	85	85
900V		A	29	45	58	65	72	85	85	
1000V		A	29	45	58	65	72	85	85	
1100V		A	29	45	54	-	60	68	-	
1200V		A	29	45	50	50	56	65	65	
1300V		A	26	39	44	-	50	61	-	
1400V		A	23	33	38	-	46	-	-	
1500V		A	20	26	32	32	42	55	55	

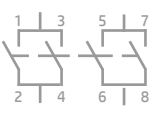
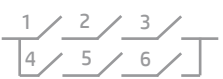
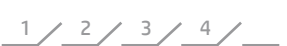

Technical Data continued

Data according to IEC 60947-3, VDE 0660, GB14048.3

Main Contacts		Type	SI16	SI25	SI32	SI38	SI40	SI55	SI65			
Rated operational current I_n 1 pole 1		300V	A	16	23	27	27	40	55	-		
		400V	A	14	18	20	20	30	40	-		
		500V	A	10	12	14	14	19	25	-		
		600V	A	5	6	8	8	10	13	-		
		700V	A	1.5	2	3	3	7	10	-		
		800V	A	1.5	2	3	3	6	8	-		
		900V	A	1	1.5	2	2	5	6	-		
		1000V	A	1	1.5	2	2	3	4	-		
		2 poles in series 2		500V	A	16	25	32	38	40	55	65
				600V	A	14	21	27	31	40	55	65
700V	A			13	19	22	25	35	55	65		
800V	A			12	15	17	19	33	49	52		
900V	A			8	10	12	14	25	35	38		
1000V	A			4	5	6	7	16	20	20		
1100V	A			3	4	5	-	11	15	-		
1200V	A			2	3	4	4	8	12	12		
1300V	A			1.5	2	3	-	7	10	-		
1400V	A			1	2	3	-	7	9	-		
1500V	A			1	1.5	2	2	6	8	8		
2 poles in series + 2 poles parallel 2H				500V	A	25	39	50	58	72	85	85
				600V	A	20	32	35	38	60	75	75
				700V	A	13	19	22	25	38	60	65
				800V	A	12	15	17	19	33	49	52
		900V	A	8	10	12	14	25	35	38		
		1000V	A	4	5	6	7	16	20	20		
		1100V	A	3	4	5	-	11	15	-		
		1200V	A	2	3	4	4	8	12	12		
		1300V	A	1.5	2	3	-	7	10	-		
		1400V	A	1	2	3	-	7	9	-		
		1500V	A	1	1.5	2	2	6	8	8		
		3 poles in series + 2 poles parallel 3H		500V	A	24	45	58	65	72	85	-
				600V	A	22	34	44	48	72	-	-
				700V	A	20	28	34	35	62	69	-
				800V	A	18	24	29	31	53	61	-
900V	A			16	20	24	24	55	-	-		
1000V	A			14	18	20	20	35	50	-		
1100V	A			-	-	-	-	-	-	-		
1200V	A			11	13	15	15	-	-	-		
1300V	A			-	-	-	-	-	-	-		
1400V	A			-	-	-	-	-	-	-		
1500V	A			4	6	8	8	-	-	-		
4 poles in series 4S, 4B, 4T				500V	A	16	25	32	45	48	55	65
				600V	A	16	25	32	45	48	55	65
				700V	A	16	25	32	45	48	55	65
				800V	A	16	25	32	38	40	55	65
		900V	A	16	25	32	38	40	55	65		
		1000V	A	16	25	32	38	40	55	65		
		1100V	A	15	25	32	-	-	55	-		
		1200V	A	13.5	21	27	27	40	55	55		
		1300V	A	12	19	24	-	-	50	-		
		1400V	A	10.5	16	21	-	-	45	-		
		1500V	A	9	14	18	18	30	40	40		
		4 poles in series + 2 poles parallel 4H		500V	A	29	45	58	65	72	85	-
				600V	A	29	45	58	65	72	85	-
				700V	A	25	40	53	65	72	80	-
				800V	A	21	35	45	60	67	75	-
900V	A			18	30	37	55	59	70	-		
1000V	A			16	25	32	50	52	64	-		
1100V	A			-	-	-	-	44	59	-		
1200V	A			13.5	21	27	27	40	55	-		
1300V	A			-	-	-	-	36	50	-		
1400V	A			-	-	-	-	33	45	-		
1500V	A			9	14	18	18	30	40	-		

Technical Data continued







Data according to IEC 60947-3, VDE 0660, GB14048.3

Main Contacts		Type	SI16	SI25	SI32	SI38	SI40	SI55/SI65
DC22B	1 pole 1 	500V A	1	1.25	1.5	x	x	2.5
		600V A	0.5	0.75	1	x	x	2
		800V A	0.3	0.4	0.5	x	x	1.5
		1000V A	0.15	0.2	0.25	x	x	1
		1200V A				x	x	x
		1500V A				x	x	x
	2 poles in series 2 	500V A	7	8	9	x	x	x
		600V A	5.5	6	6.5	x	x	x
		800V A	2	2.5	3	x	x	x
		1000V A	1	1.5	2	x	x	x
		1200V A				x	x	x
		1500V A				x	x	x
	4 poles in series 4S, 4B, 4T 	500V A	16	25	32	x	x	x
		600V A	16	25	27.5	x	x	x
		800V A	11.5	12	12.5	x	x	x
		1000V A	8	9	10	x	x	x
		1200V A				x	x	x
		1500V A				x	x	x
Rated conditional short-circuit current		kA _{eff}	5	5	5	5	10	10
Max. fuse size		gL (gG)	40	63	80	80	125	160
Mechanical Life		x10 ³	10	10	10	10	10	10
Rated short-time withstand current (1s)	I _{cw}	2, 4, 6, 8 A	800	900	1000	1000	2, 4: 1200	2, 4: 1400
		2H, 3H, 4H A	1300	1500	1700	1700	2H: 2000	2H: 2400
Short circuit making capacity	I _{cw}	2, 4, 6, 8 A	800	900	1000	1000	2, 4: 1200	2, 4: 1400
		2H, 3H, 4H A	1300	1500	1700	1700	2H: 2000	2H: 2400
Maximum cable cross sections (including jumper)			SIV-B1-1				SIV-B2-1	
solid or stranded	mm ²		4 - 16	4 - 16	4 - 16	4 - 16	2.5 - 25	2.5 - 25
flexible	mm ²		4 - 10	4 - 10	4 - 10	4 - 10	4 - 16	4 - 16
flexible (+ multicore cable end)	mm ²		4 - 10	4 - 10	4 - 10	4 - 10	2.5 - 16	2.5 - 16
Size of terminal screw			M4 Pz2	M4 Pz2	M4 Pz2	M4 Pz2	M5 Pz2	M5 Pz2
Tightening torque	Nm		1.7 - 1.8	1.7 - 1.8	1.7 - 1.8	1.7 - 1.8	2.5 - 2.8	2.5 - 2.8
2 cables per clamp without jumper								
solid or stranded	mm ²		16+(1.5-2.5)/10+(1.5-6)/6+(1.5-10)/4+(1.5-10)				16+(1.5-2.5)/10+(1.5-10)/6+(1.5-10)/4+(1.5-10)	
flexible & flexible + multicore cable end	mm ²		16+(1.5-2.5)/10+(1.5-4)/6+(1.5-6)				16+(1.5-6)/10+(1.5-10)/6+(1.5-16)/4+(1.5-16)	
stranded	AWG		8+(16-12)/10+(16-10)/12+(16-8)/14+(16-8)				3+(18-10)/4+(18-10)/6+(18-8)/8+(18-8)	
solid	AWG		10+(16-12)/12+(16-10)/14+(16-10)				10+(16-10)/12+(16-10)/14+(16-10)	
Maximum ambient temperature								
Operation	All types except PEL64R	°C	-40 to +65					
	PEL64R type	°C	-40 to +45					
Storage		°C	-50 to +90					
Power loss per switch at I_{e max.}			A	A	A		A	A
2	(A) / W	(16) / 1	(25) / 2.3	(32) / 3.7		(40) / 4	(55) / 7.5	
4	(A) / W	(16) / 2	(25) / 4.6	(32) / 7.4		(40) / 8	(55) / 15	
6	(A) / W	(16) / 3	(25) / 6.9	(32) / 11.1		(40) / 12	(55) / 22.5	
8	(A) / W	(16) / 4	(25) / 9.2	(32) / 14.8		(40) / 16	(55) / 30	
2H	(A) / W	(29) / 1.5	(45) / 3.7	(58) / 6		(72) / 6.5	(85) / 9	
3H	(A) / W	(29) / 2.3	(45) / 5.6	(58) / 9		(72) / 9.8	(85) / 14	
4H	(A) / W	(29) / 3	(45) / 7.4	(58) / 12		(72) / 13	(85) / 18	
Contact Resistance per pole		mΩ	1.75	1.75	1.75	1.75	1.25	1.25

x - In Test

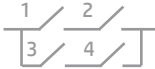
Technical Data continued

Data according to UL508i  File E362605, CCN: NMSJ and UL60947-1 & UL60947-4-1  File E146487, CCN: NRNT, NRNT7

Main Contacts		Type	SI16	SI25	SI32	SI38	SI40	SI55	SI65	
Ampere-Rating "General Use"		DC								
1 pole 1 	350V	A	4	5	6	6	7.1	10	10	
	500V	A	4	5	6	6	5.7	7	7	
	600V	A	4	5	6	6	5	5.8	5.8	
	700V	A					3.9	5	5	
	800V	A					3.2	4.4	4.4	
	900V	A					2.5	3.5	3.5	
	1000V	A					1.5	2	2	
2 poles in series 2 	350V	A	16	25	32	45	48	55	65	
	500V	A	16	25	32	45	48	55	65	
	600V	A	16	25	32	36	40	55	65	
	700V	A					32	46	50	
	800V	A					26	37	40	
	900V	A					20	28	32	
2 poles in series + 2 poles parallel 2H 	350V	A	29	45	58	58	72	85	85	
	500V	A	29	41	43	45	53	66	73	
	600V	A	21	30	33	36	42	55	65	
	700V	A					35	47	50	
	800V	A					30	40	40	
	900V	A					26	32	32	
4 poles in series 4S, 4B, 4T 	350V	A	16	25	32	45	48	55	65	
	500V	A	16	25	32	45	48	55	65	
	600V	A	16	25	32	36	40	55	65	
	700V	A					40	55	65	
	800V	A					40	55	65	
	900V	A					40	55	65	
3 poles in series + 2 poles parallel 3H 	350V	A	29	45	58	58	72	85	85	
	500V	A	29	41	50	50	56	80	85	
	600V	A	21	38	45	45	52	65	72	
	700V	A					46	58	66	
	800V	A					40	51	60	
	900V	A					36	45	54	
4 poles in series + 2 poles parallel 4H 	350V	A	29	45	58	58	80	85	85	
	500V	A	29	45	58	58	71	85	85	
	600V	A	29	45	50	50	65	85	85	
	700V	A					58	76	85	
	800V	A					51	71	76	
	900V	A					45	67	73	
AC Rating "General Use"	2 poles in series 	600V	A	16	25	32		40	55	-
		277V	A			50		72	85	-
3 poles parallel		3x480V	A			32		40	55	-
Fuse size (RKS) Industrial Control Switch										
5kA / 600V		A	40	60	80	80	-	-	-	
5kA / 1000V		A					160	160	160	
Maximum cable cross sections		(including jumper SIV-B1-1/B2-1)								
solid or stranded		AWG	12 - 10	12 - 10	12 - 10	12 - 10	16 - 10	16 - 10	16 - 10	
flexible		AWG	12 - 6	12 - 6	12 - 6	12 - 6	14 - 4	14 - 4	14 - 4	
flexible (+ multicore cable end)		AWG	12 - 6	12 - 6	12 - 6	12 - 6				
Size of terminal screw			M4 Pz2	M4 Pz2	M4 Pz2	M4 Pz2	M5 Pz2	M5 Pz2	M5 Pz2	
Tightening torque		lb.inch	9 - 16	9 - 16	9 - 16	9 - 16	22 - 25	22 - 25	22 - 25	

x - In Test

Technical Data continued

Switch SI16 2 poles DC-PV1 Open Type

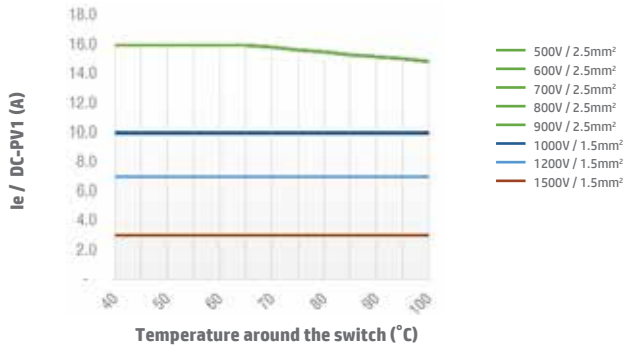

Switch SI16 2 poles DC-PV1 Enclosed Type

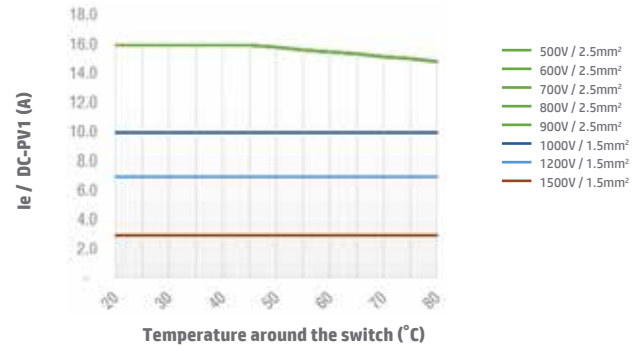

Switch SI16 2H DC-PV1 Open Type

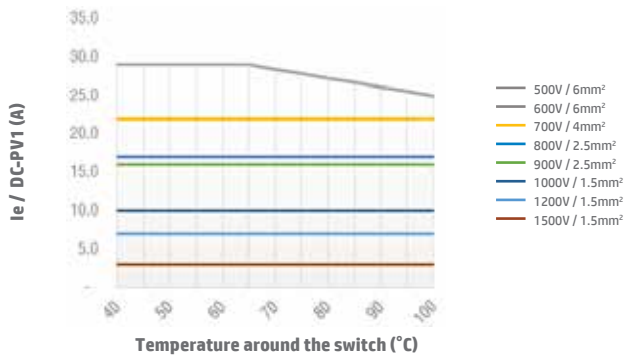

Switch SI16 2H DC-PV1 Enclosed Type

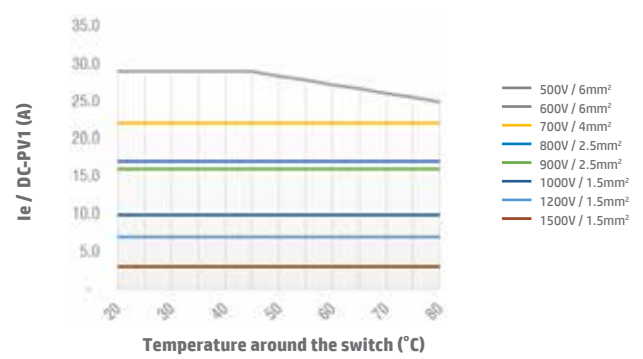

Switch SI16 4B/4S/4T DC-PV1 Open Type

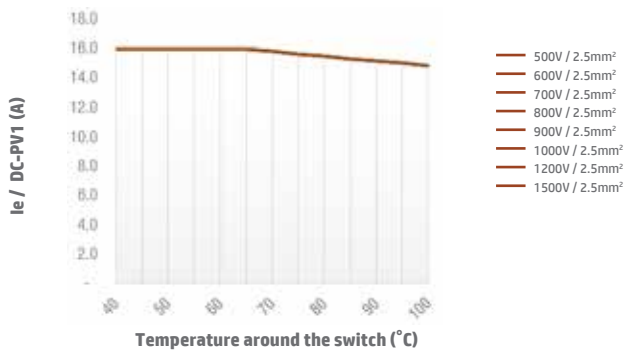

Switch SI16 4B/4S/4T DC-PV1 Enclosed Type

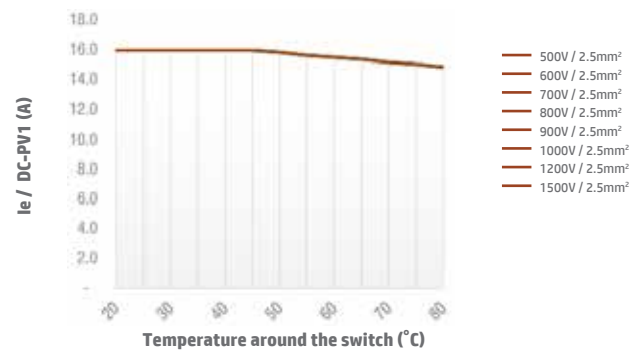

Switch SI16 4H DC-PV1 Open Type

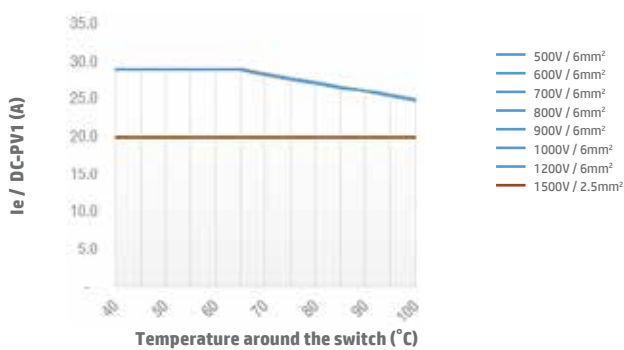

Switch SI16 4H DC-PV1 Enclosed Type

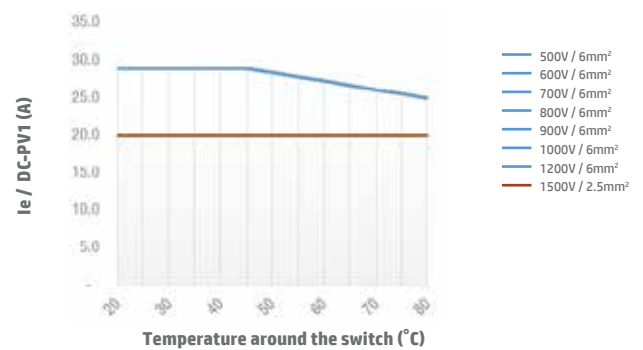

Technical Data continued

Switch SI25 2 poles DC-PV1 Open Type

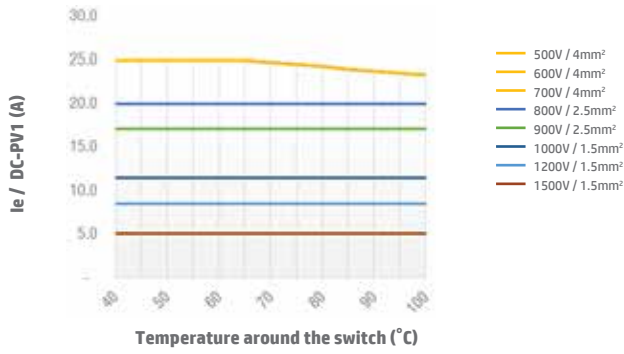

Switch SI25 2 poles DC-PV1 Enclosed Type

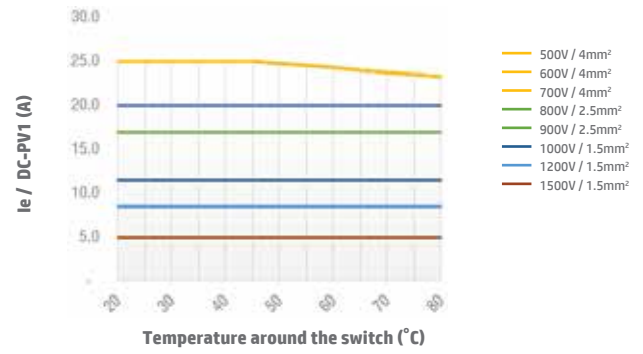

Switch SI25 2H DC-PV1 Open Type

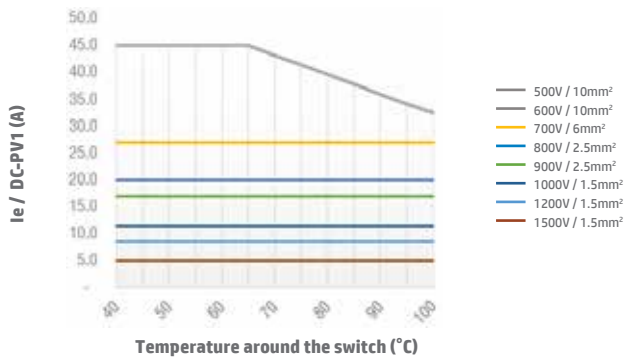

Switch SI25 2H DC-PV1 Enclosed Type

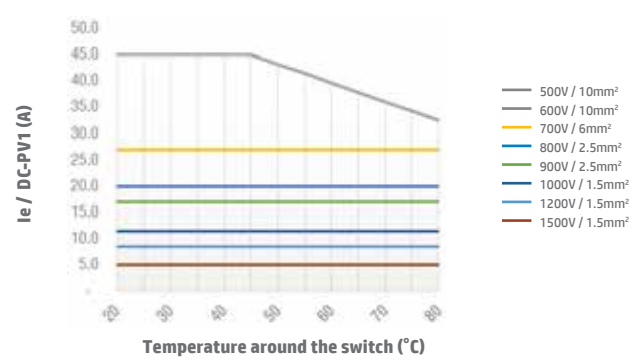

Switch SI25 4B/4S/4T DC-PV1 Open Type

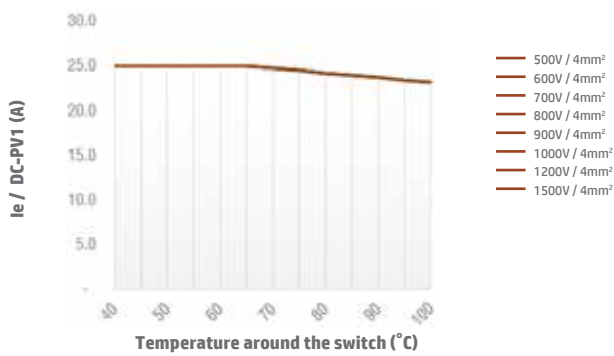

Switch SI25 4B/4S/4T DC-PV1 Enclosed Type

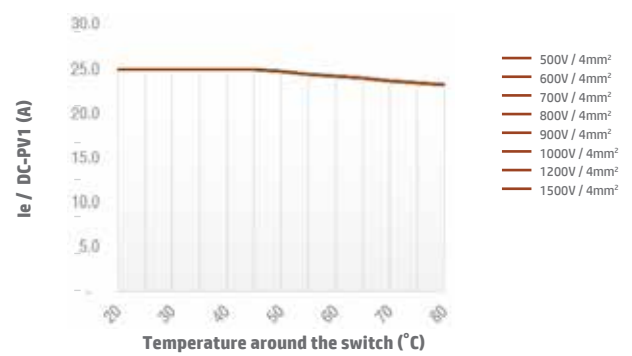

Switch SI25 4H DC-PV1 Open Type

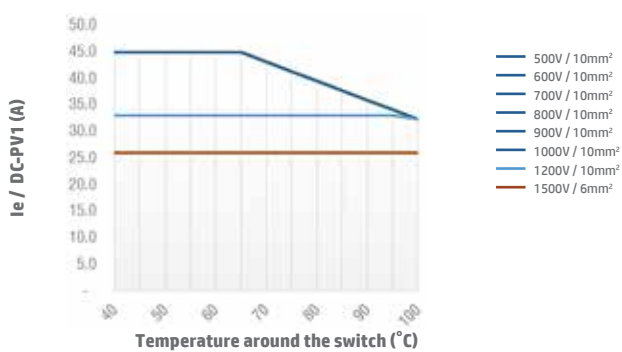

Switch SI25 4H DC-PV1 Enclosed Type

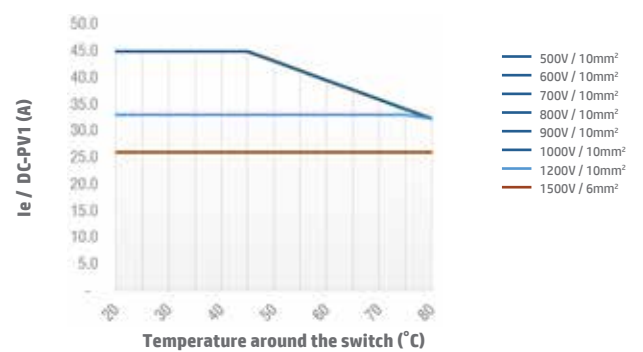

Technical Data continued

Switch SI32 2 poles DC-PV1 Open Type

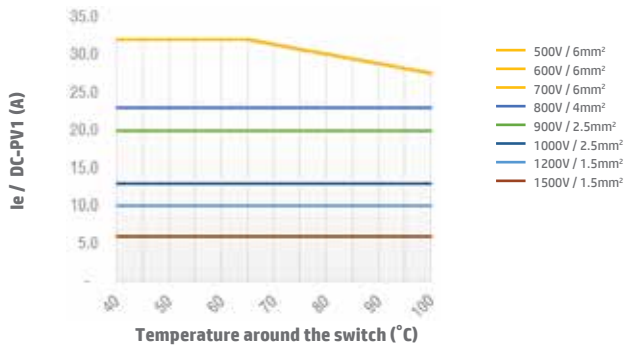

Switch SI32 2 poles DC-PV1 Enclosed Type

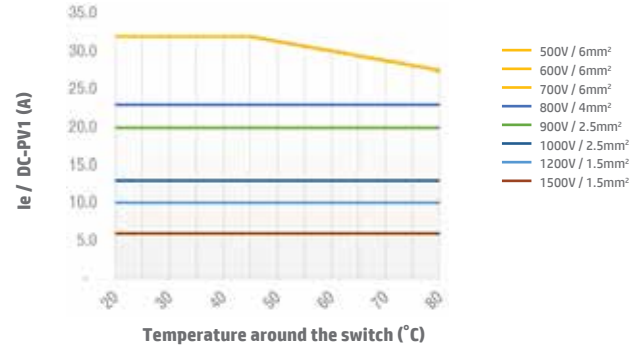

Switch SI32 2H DC-PV1 Open Type

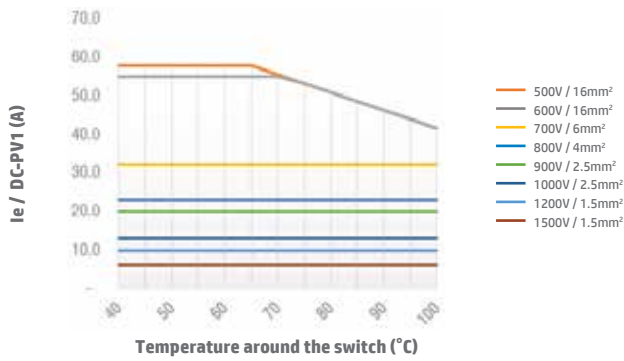

Switch SI32 2H DC-PV1 Enclosed Type

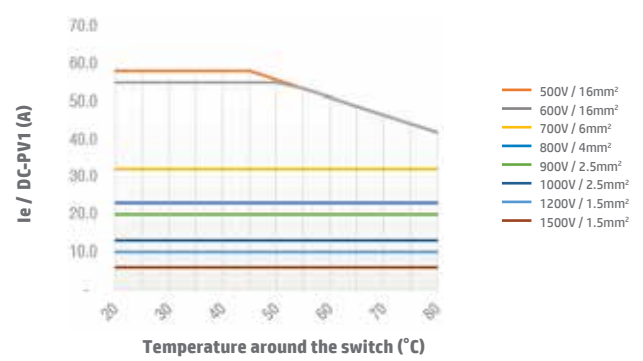

Switch SI32 4B/4S/4T DC-PV1 Open Type

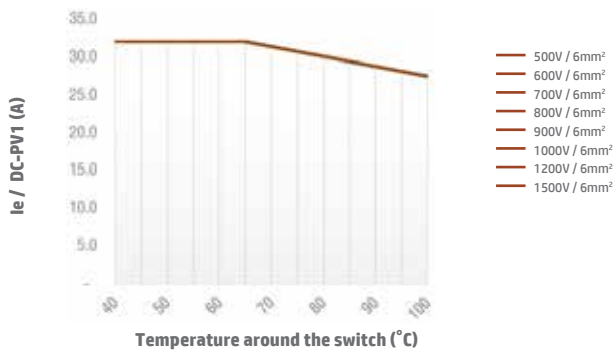

Switch SI32 4B/4S/4T DC-PV1 Enclosed Type

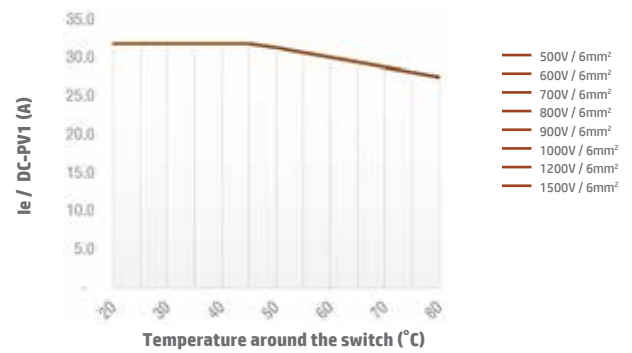

Switch SI32 4H DC-PV1 Open Type

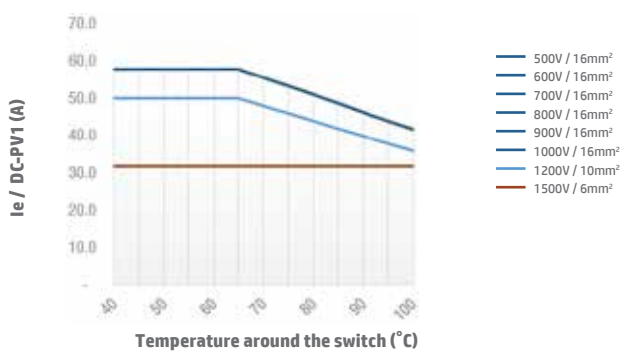

Switch SI32 4H DC-PV1 Enclosed Type

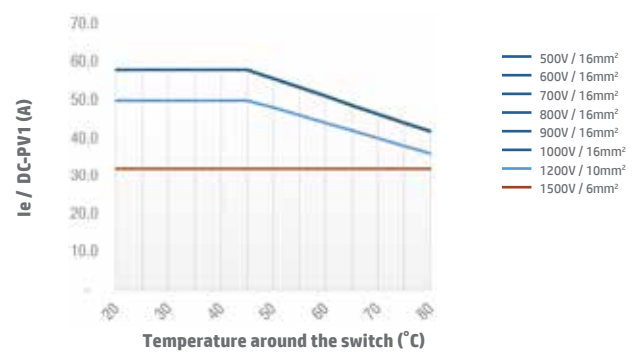

Technical Data continued

Switch SI38 2 poles DC-PV1 Open Type

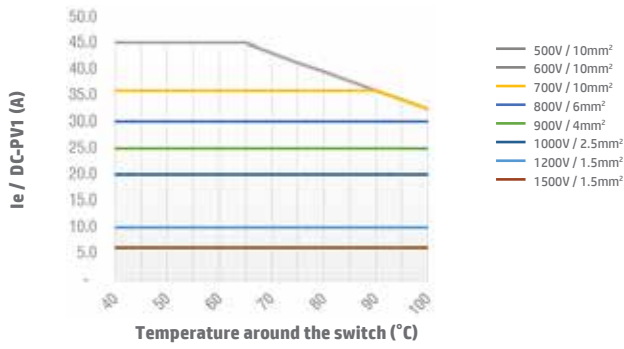

Switch SI38 2 poles DC-PV1 Enclosed Type

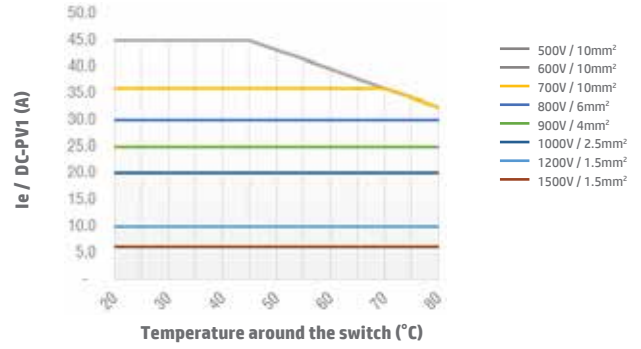

Switch SI38 2H DC-PV1 Open Type

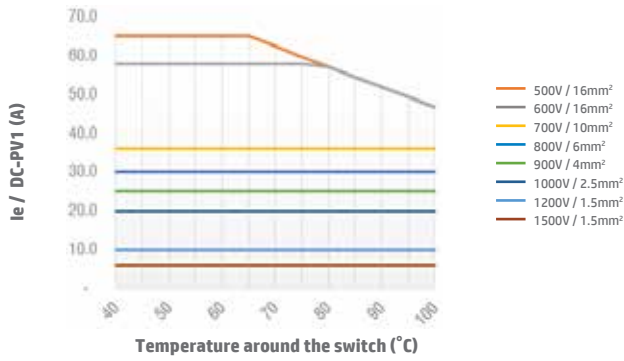

Switch SI38 2H DC-PV1 Enclosed Type

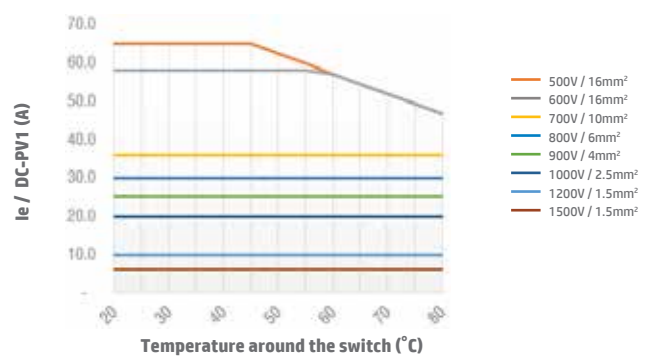

Switch SI38 4B/4S/4T DC-PV1 Open Type

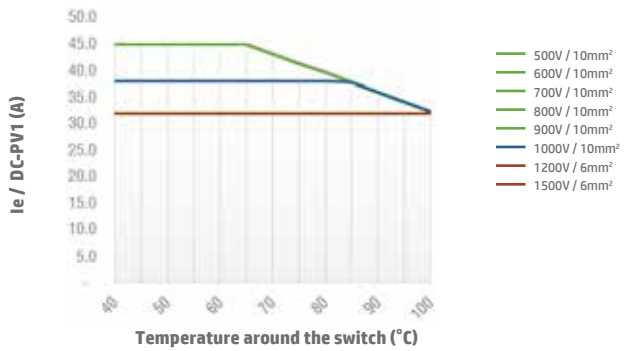

Switch SI38 4B/4S/4T DC-PV1 Enclosed Type

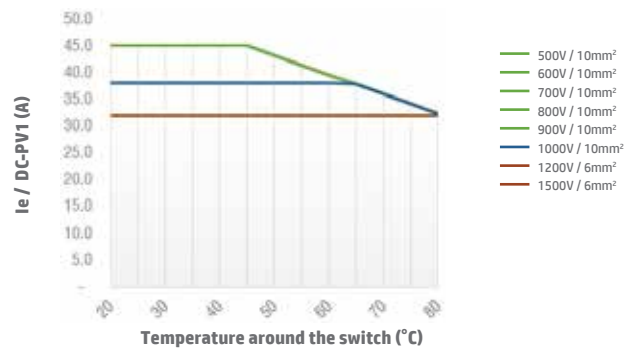

Switch SI38 4H DC-PV1 Open Type

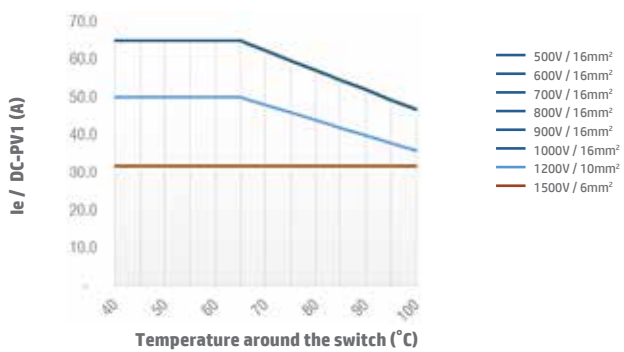

Switch SI38 4H DC-PV1 Enclosed Type

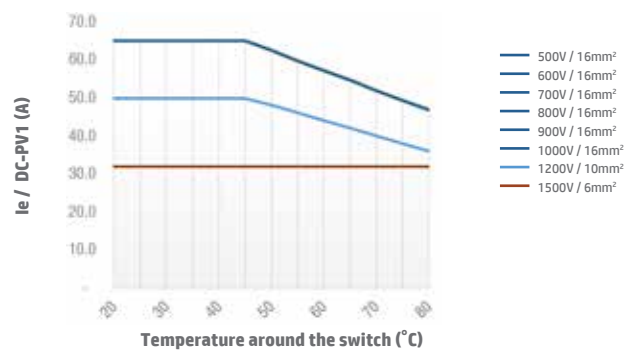

Technical Data continued

Switch SI40 2 poles DC-PV1 Open Type

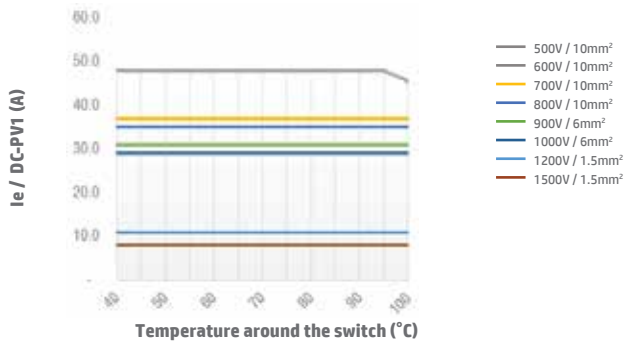

Switch SI40 2 poles DC-PV1 Enclosed Type

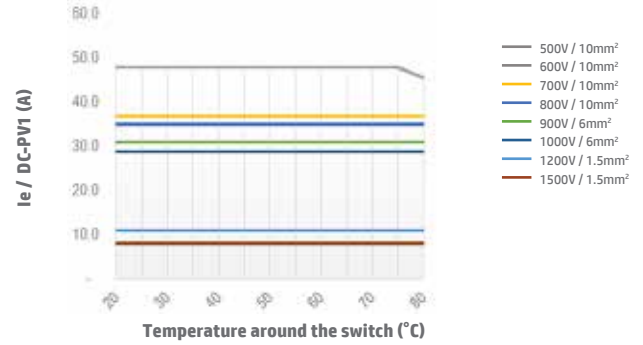

Switch SI40 2H DC-PV1 Open Type

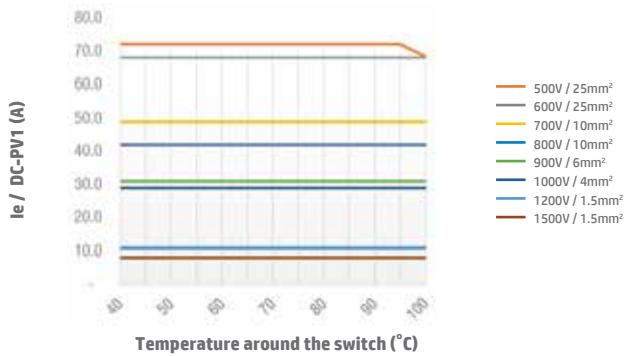

Switch SI40 2H DC-PV1 Enclosed Type

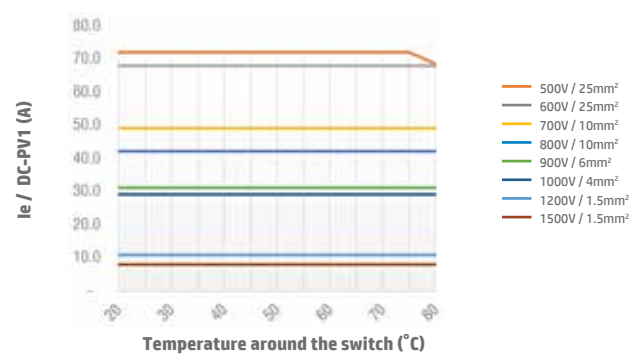

Switch SI40 4B/4S/4T DC-PV1 Open Type

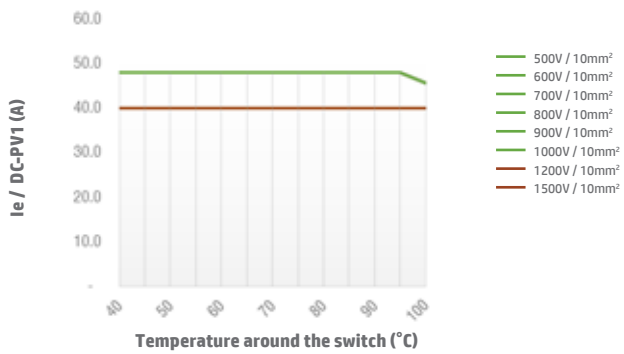

Switch SI40 4B/4S/4T DC-PV1 Enclosed Type

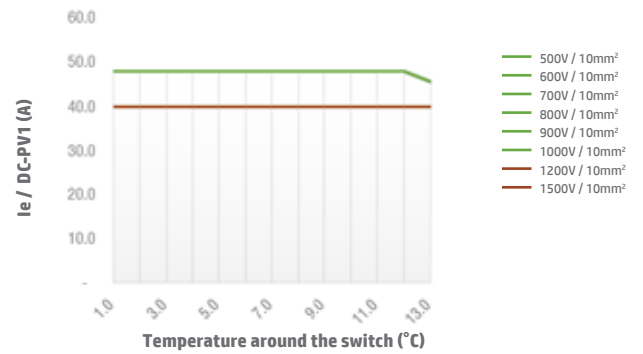

Switch SI40 4H DC-PV1 Open Type

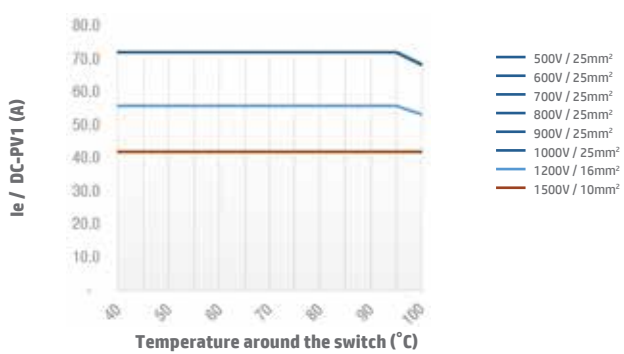

Switch SI40 4H DC-PV1 Enclosed Type

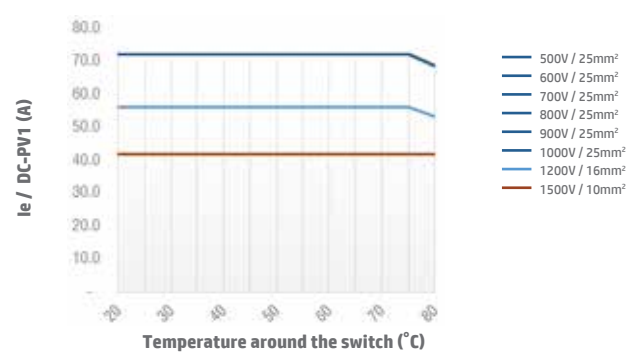

Note: For SI40 3H pole configuration, DC-PV1 derating graphs can be supplied upon request. Please contact IMO for more information.

Technical Data continued

Switch SI55 2 poles DC-PV1 Open Type

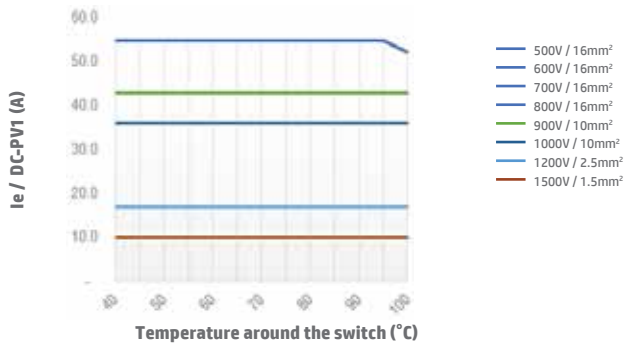

Switch SI55 2 poles DC-PV1 Enclosed Type

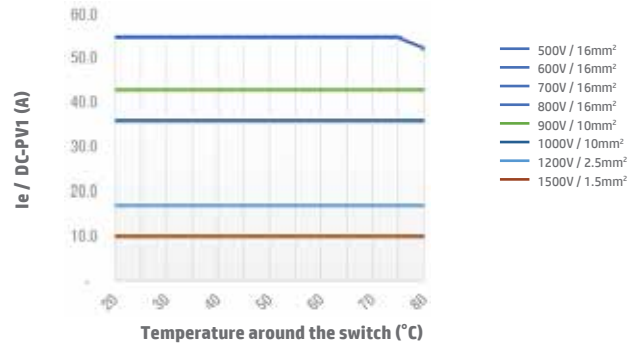

Switch SI55 2H DC-PV1 Open Type

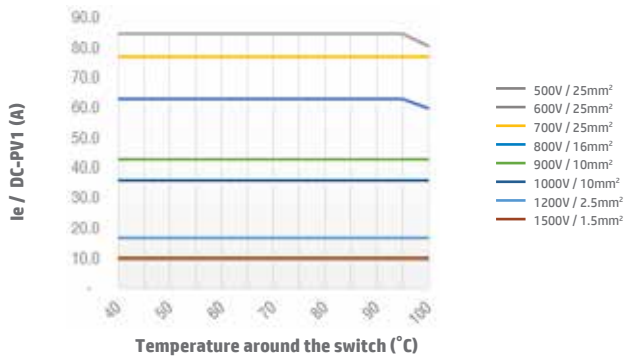

Switch SI55 2H DC-PV1 Enclosed Type

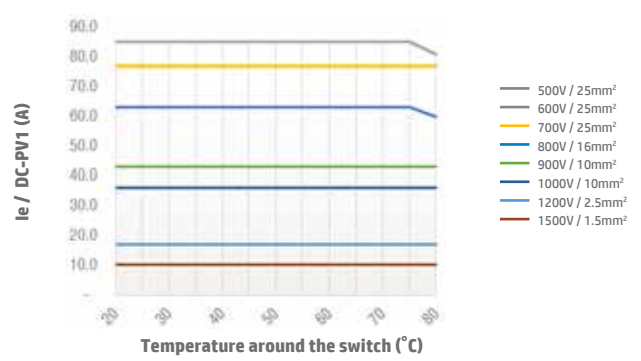

Switch SI55 4B/4S/4T DC-PV1 Open Type

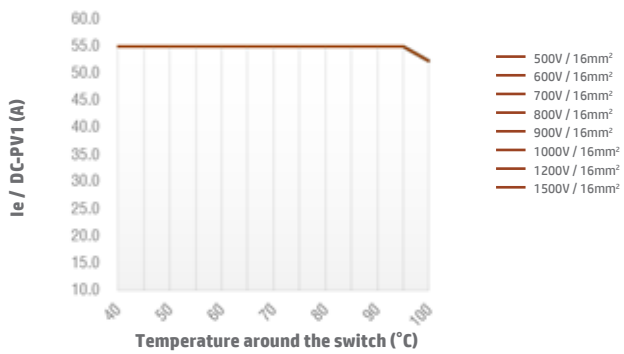

Switch SI55 4B/4S/4T DC-PV1 Enclosed Type

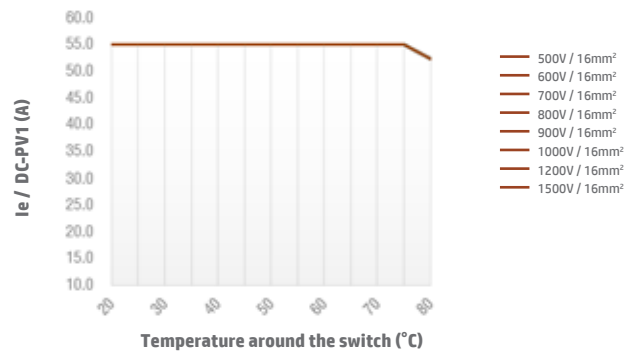

Switch SI55 4H DC-PV1 Open Type

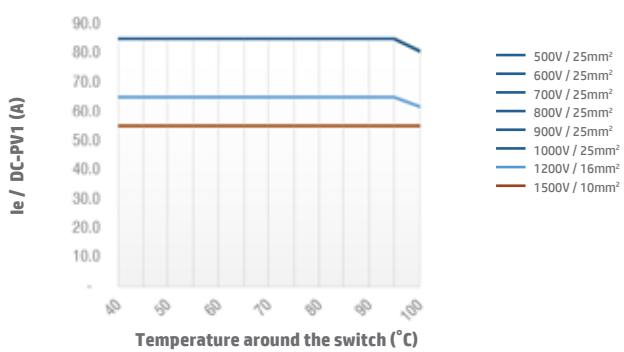

Switch SI55 4H DC-PV1 Enclosed Type

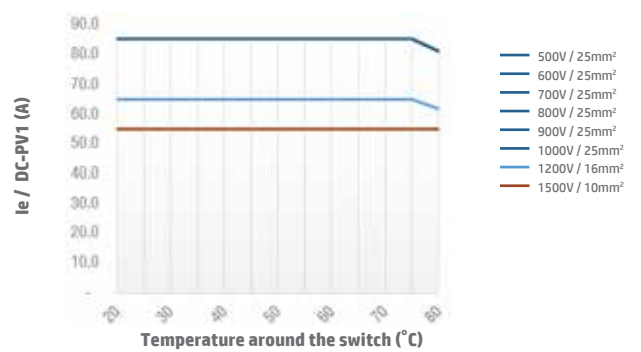

Note: SI55 3H pole configuration and SI65, DC-PV1 derating graphs can be supplied upon request. Please contact IMO for more information.

Technical Data continued

Switch SI16 2 poles DC-PV2 Open Type

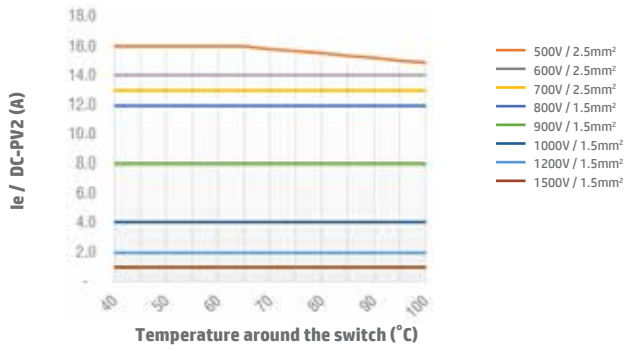

Switch SI16 2 poles DC-PV2 Enclosed Type

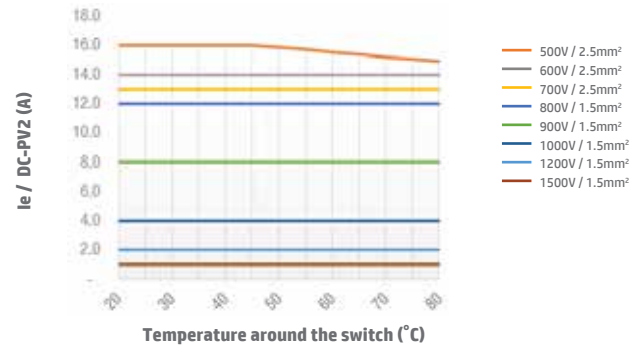

Switch SI16 2H DC-PV2 Open Type

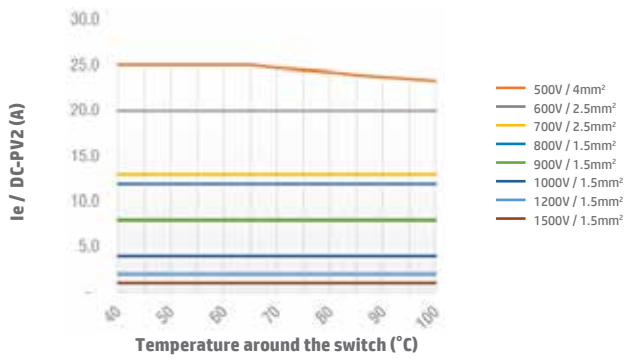

Switch SI16 2H DC-PV2 Enclosed Type

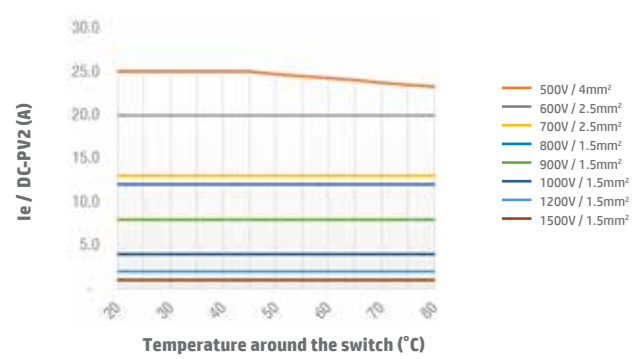

Switch SI16 4B/4S/4T DC-PV2 Open Type

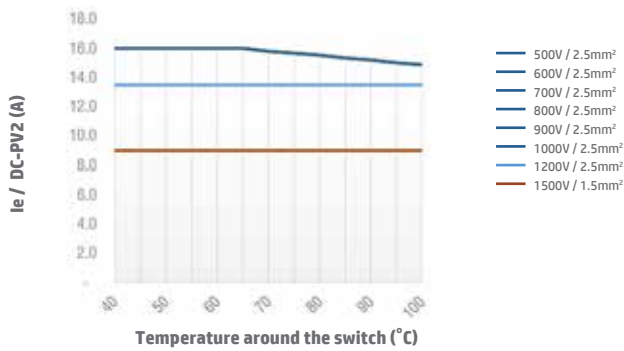

Switch SI16 4B/4S/4T DC-PV2 Enclosed Type

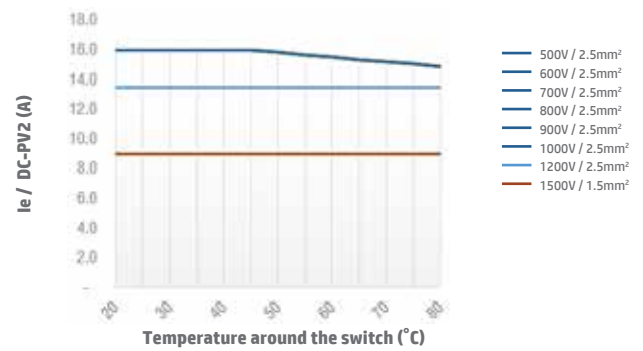

Switch SI16 4H DC-PV2 Open Type

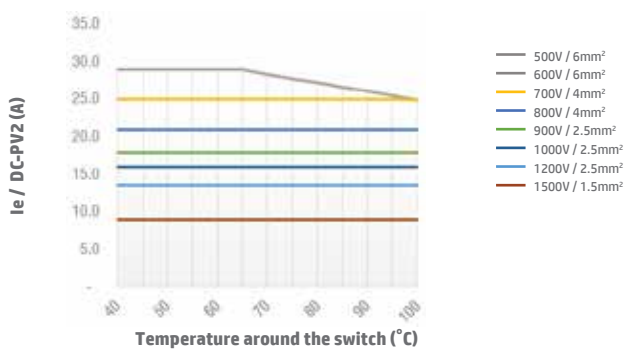

Switch SI16 4H DC-PV2 Enclosed Type

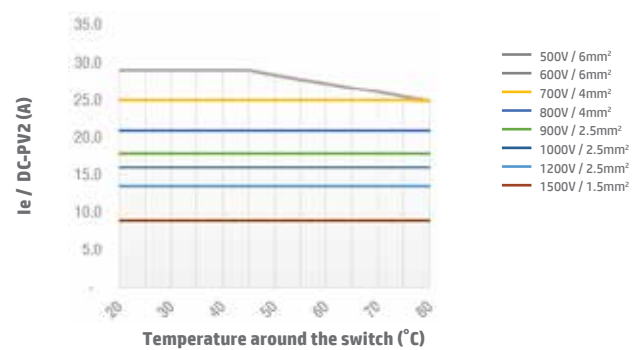

Note: For SI16 3H pole configuration, DC-PV2 derating graphs can be supplied upon request. Please contact IMO for more information.

Technical Data continued

Switch SI25 2 poles DC-PV2 Open Type

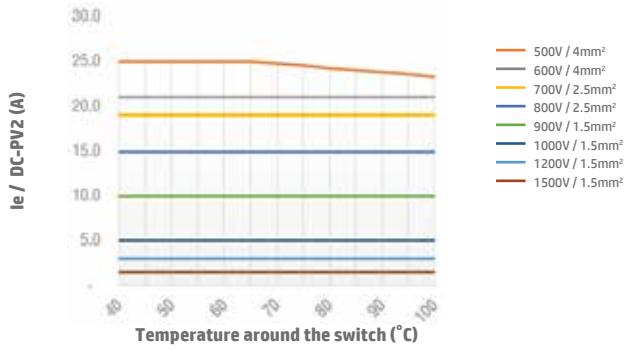

Switch SI25 2 poles DC-PV2 Enclosed Type

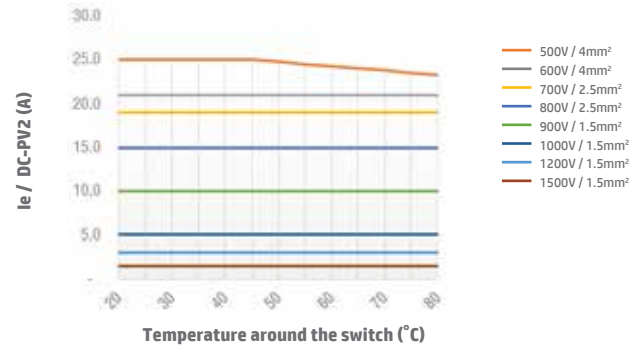

Switch SI25 2H DC-PV2 Open Type

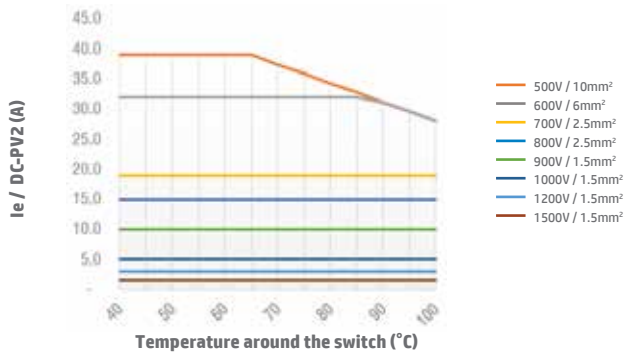

Switch SI25 2H DC-PV2 Enclosed Type

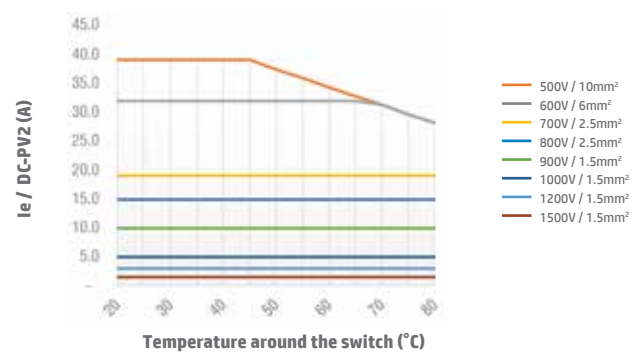

Switch SI25 4B/4S/4T DC-PV2 Open Type

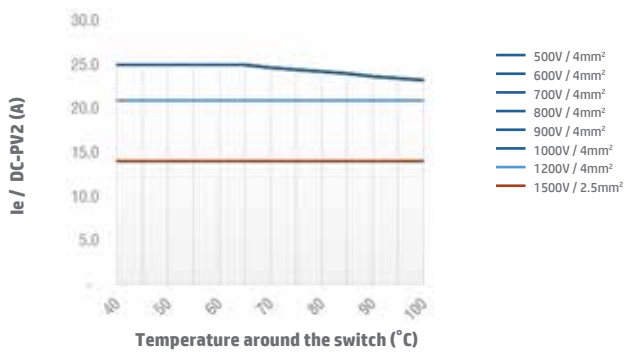

Switch SI25 4B/4S/4T DC-PV2 Enclosed Type

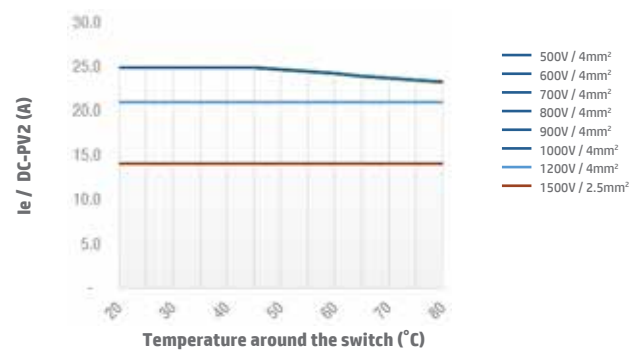

Switch SI25 4H DC-PV2 Open Type

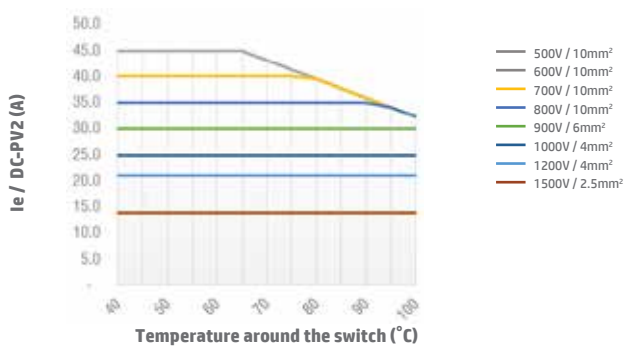

Switch SI25 4H DC-PV2 Enclosed Type

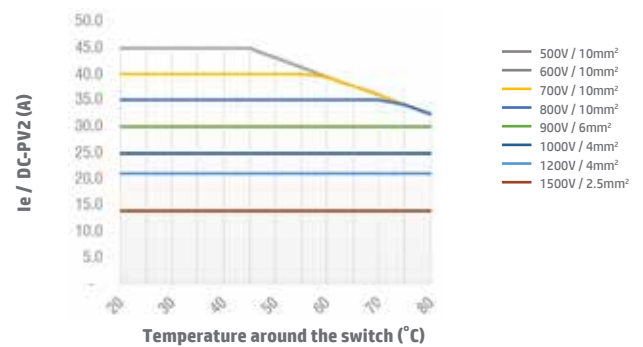

Note: For SI25 3H pole configuration, DC-PV2 derating graphs can be supplied upon request. Please contact IMO for more information.

Technical Data continued

Switch SI32 2 poles DC-PV2 Open Type

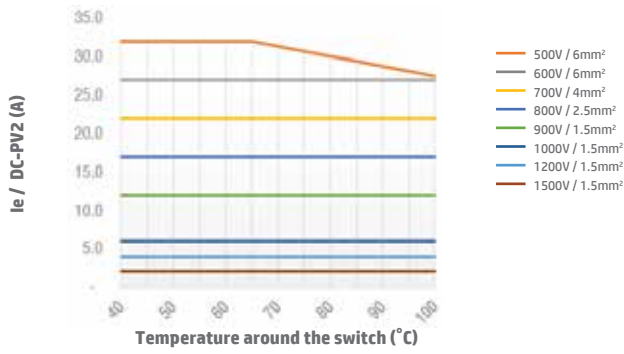

Switch SI32 2 poles DC-PV2 Enclosed Type

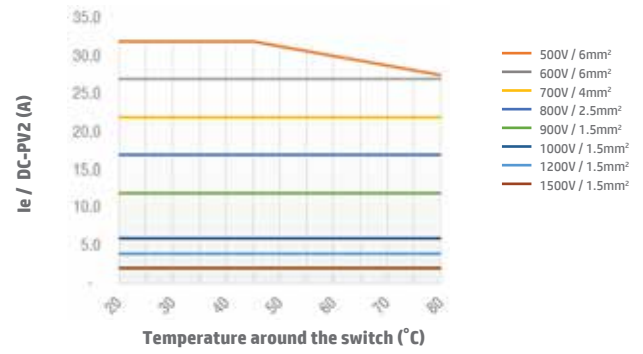

Switch SI32 2H DC-PV2 Open Type

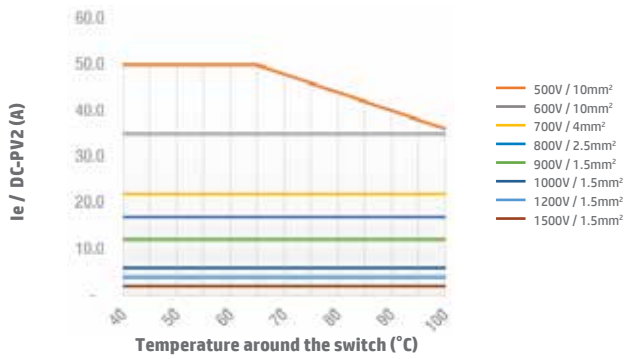

Switch SI32 2H DC-PV2 Enclosed Type

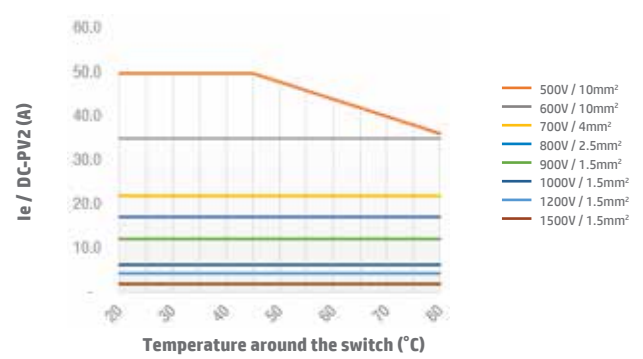

Switch SI32 4B/4S/4T DC-PV2 Open Type

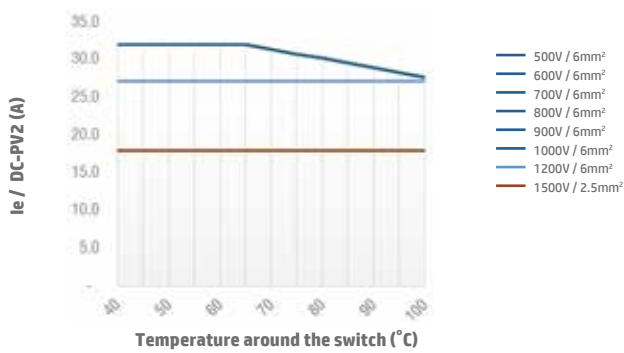

Switch SI32 4B/4S/4T DC-PV2 Enclosed Type

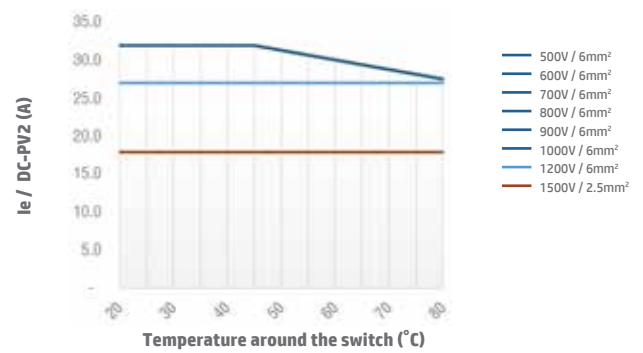

Switch SI32 4H DC-PV2 Open Type

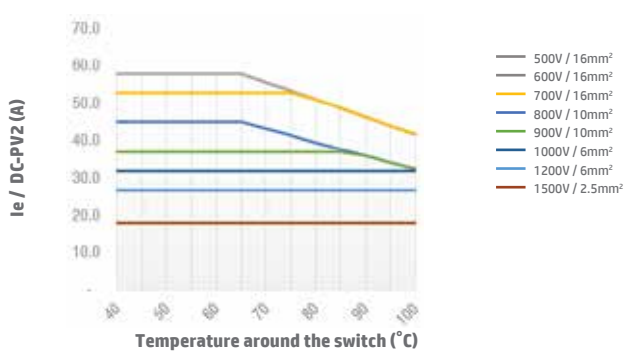

Switch SI32 4H DC-PV2 Enclosed Type

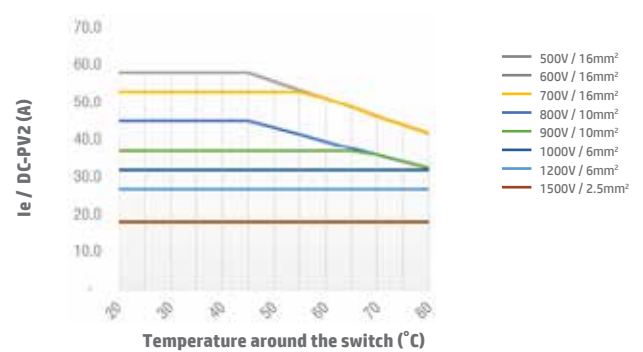

Note: For SI32 3H pole configuration, DC-PV2 derating graphs can be supplied upon request. Please contact IMO for more information.

Technical Data continued

Switch SI38 2 poles DC-PV2 Open Type

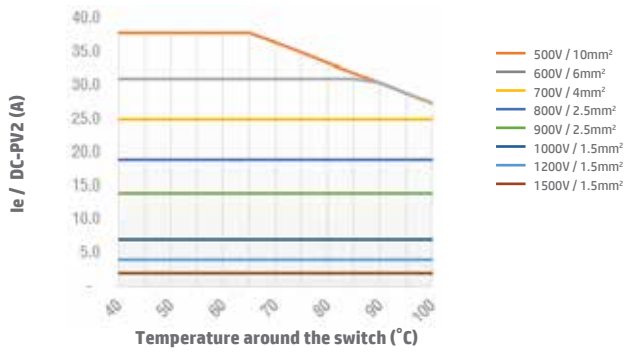

Switch SI38 2 poles DC-PV2 Enclosed Type

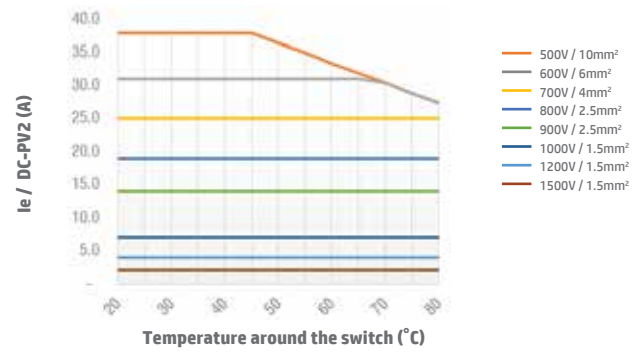

Switch SI38 2H DC-PV2 Open Type

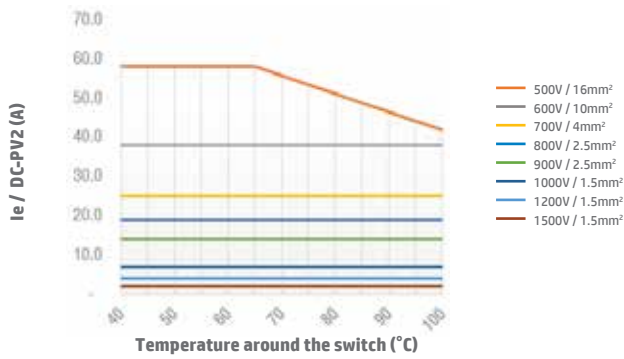

Switch SI38 2H DC-PV2 Enclosed Type

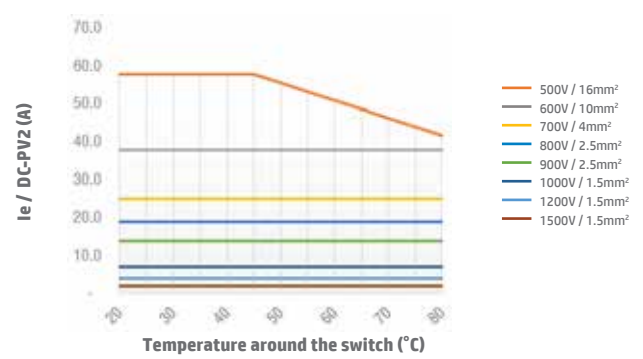

Switch SI38 4B/4S/4T DC-PV2 Open Type

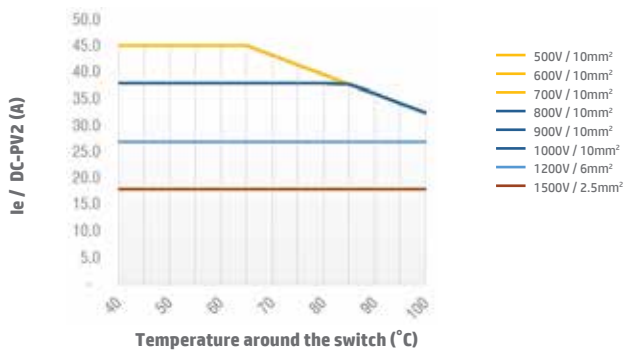

Switch SI38 4B/4S/4T DC-PV2 Enclosed Type

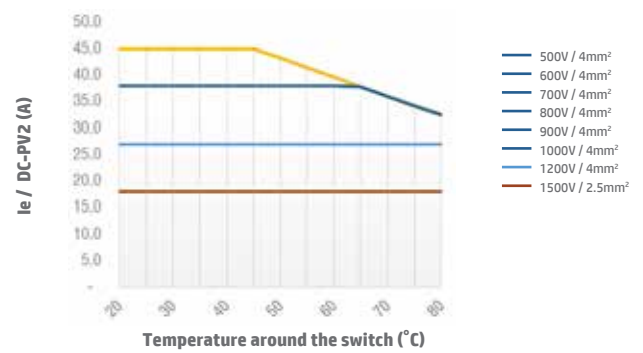

Switch SI38 4H DC-PV2 Open Type

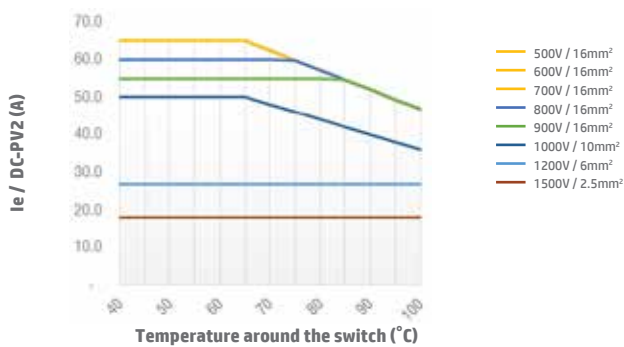

Switch SI38 4H DC-PV2 Enclosed Type

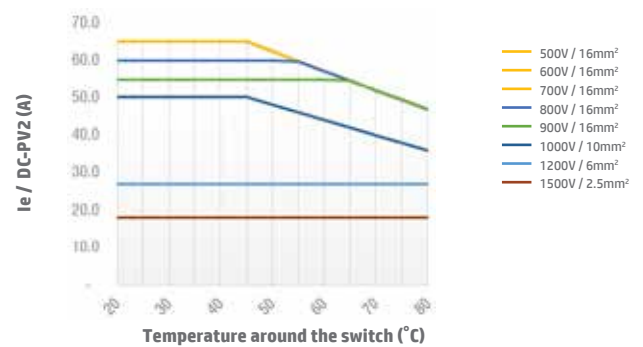

Note: For SI38 3H pole configuration, DC-PV2 derating graphs can be supplied upon request. Please contact IMO for more information.

Technical Data continued

Switch SI40 2 poles DC-PV2 Open Type

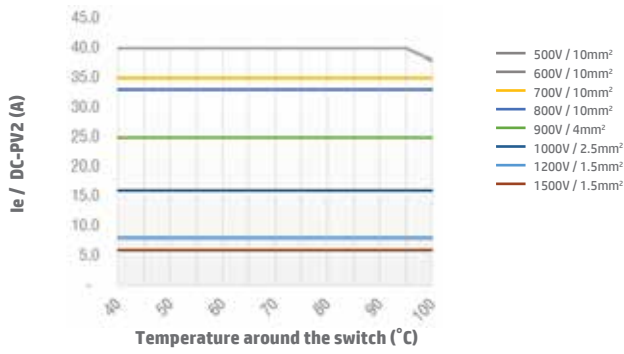

Switch SI40 2 poles DC-PV2 Enclosed Type

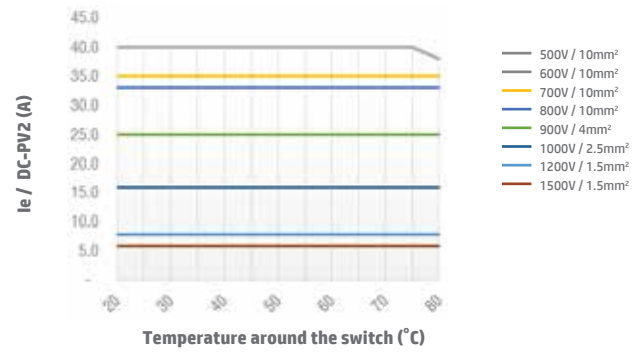

Switch SI40 2H DC-PV2 Open Type

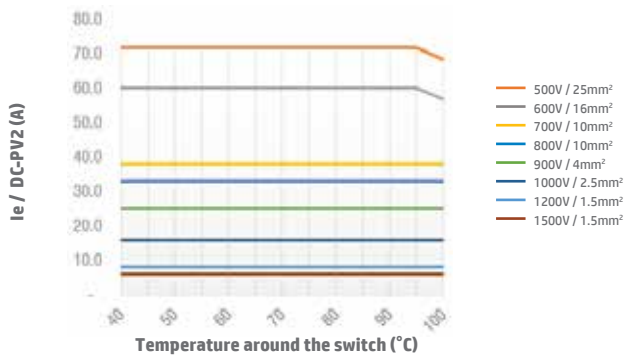

Switch SI40 2H DC-PV2 Enclosed Type

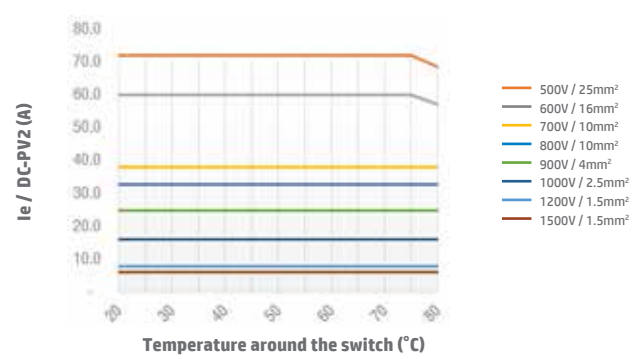

Switch SI40 4B/4S/4T DC-PV2 Open Type

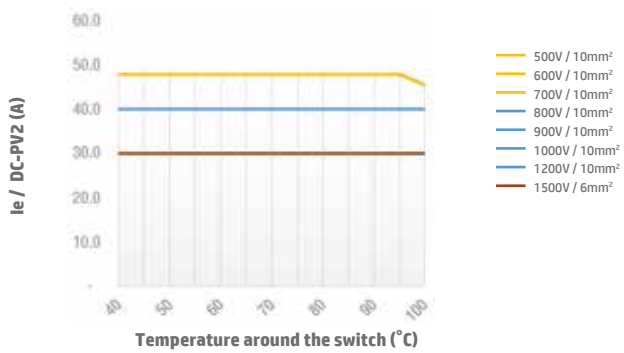

Switch SI40 4B/4S/4T DC-PV2 Enclosed Type

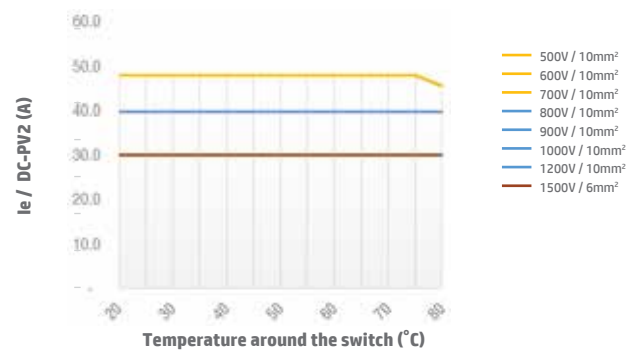

Switch SI40 4H DC-PV2 Open Type

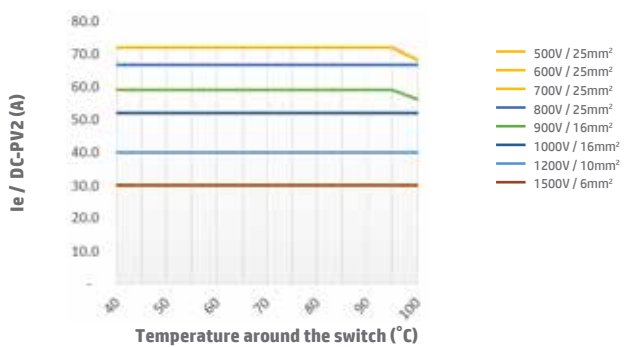

Switch SI40 4H DC-PV2 Enclosed Type

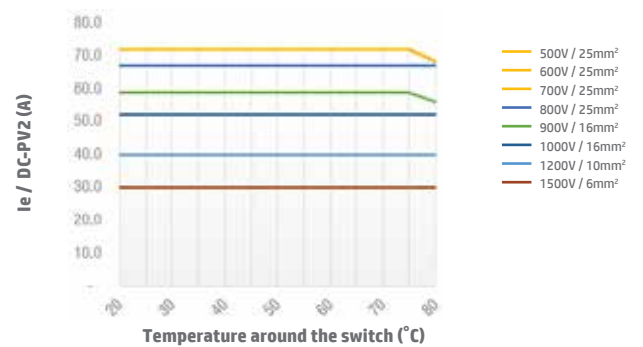

Note: For SI40 3H pole configuration, DC-PV2 derating graphs can be supplied upon request. Please contact IMO for more information.

Technical Data continued

Switch SI55 2 poles DC-PV2 Open Type

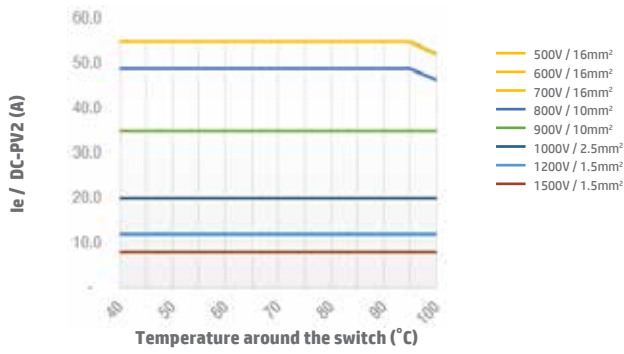

Switch SI55 2 poles DC-PV2 Enclosed Type

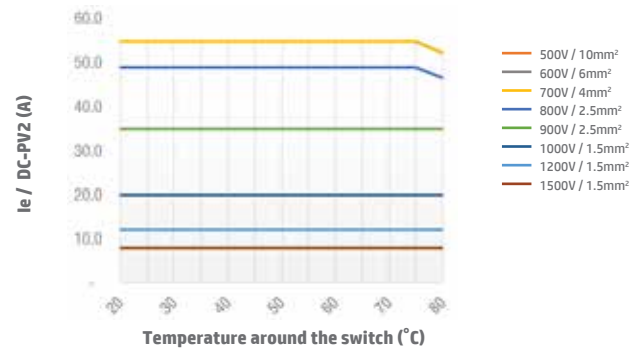

Switch SI55 2H DC-PV2 Open Type

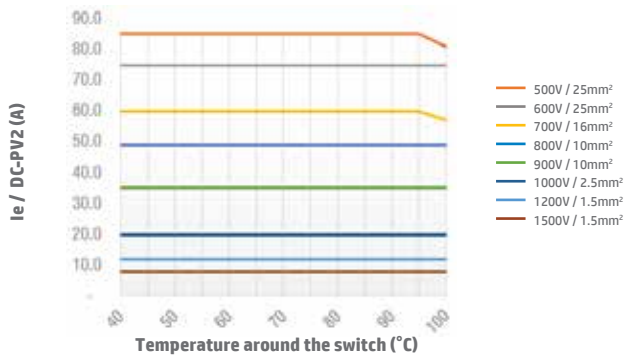

Switch SI55 2H DC-PV2 Enclosed Type

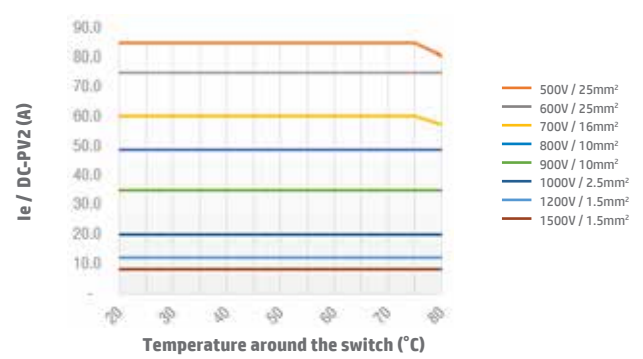

Switch SI55 4B/4S/4T DC-PV2 Open Type

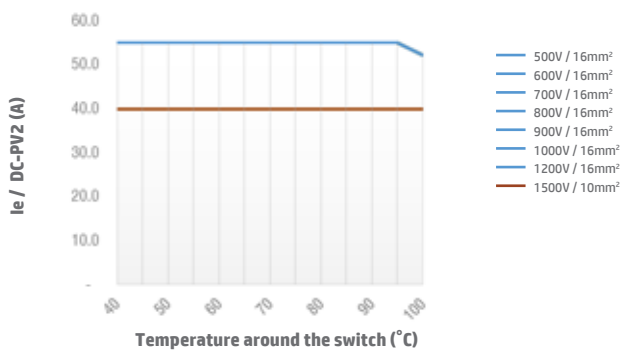

Switch SI55 4B/4S/4T DC-PV2 Enclosed Type

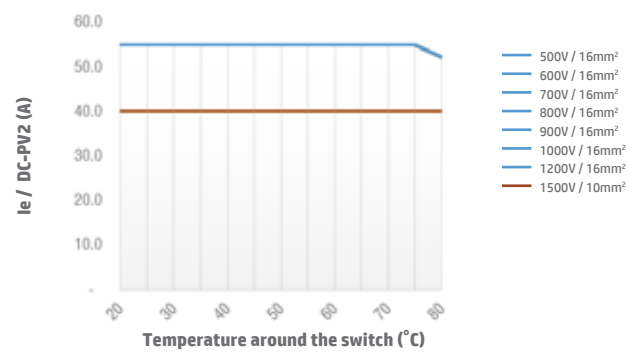

Switch SI55 4H DC-PV2 Open Type

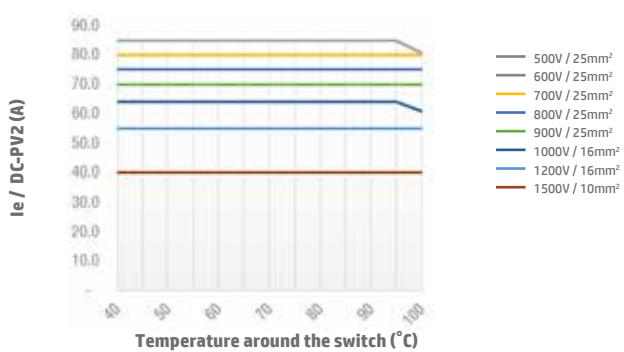

Switch SI55 4H DC-PV2 Enclosed Type

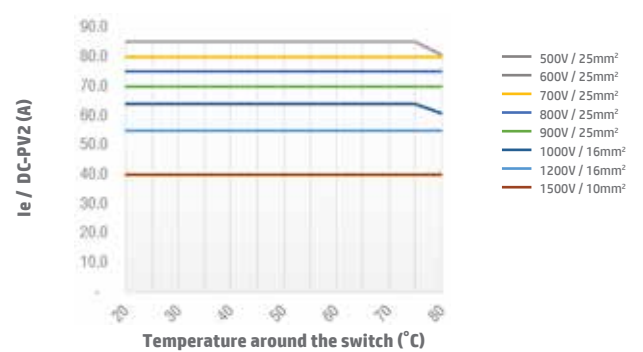

Note: SI55 3H pole configuration and SI65, DC-PV2 derating graphs can be supplied upon request. Please contact IMO for more information.

Dimensions (mm)

SI16PM / SI25PM / SI32PM / SI38PM
2

2H, 4

SI16PM / SI25PM / SI32PM / SI38PM
6, 3H, 8, 4H

SI + X "Y"
Extended Switch Shaft

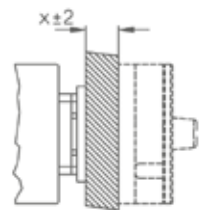
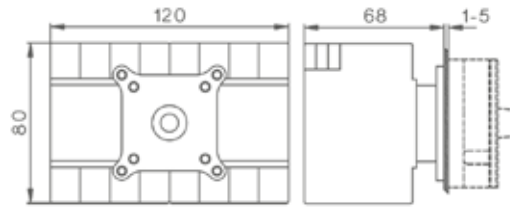
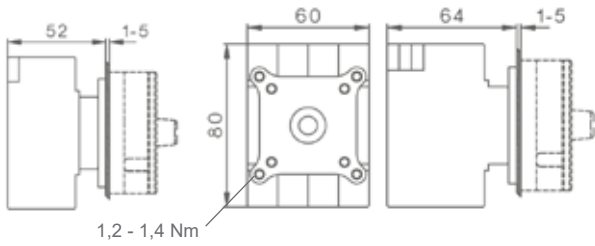

SI40PM / SI55PM / SI65PM
2, 2H, 4

SI40PM / SI55PM / SI65PM
6, 3H, 8, 4H

Mounting Hole

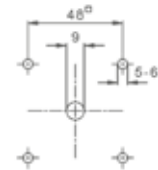
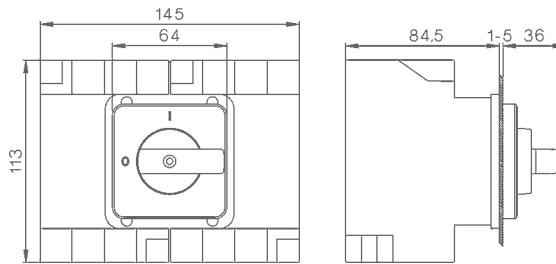
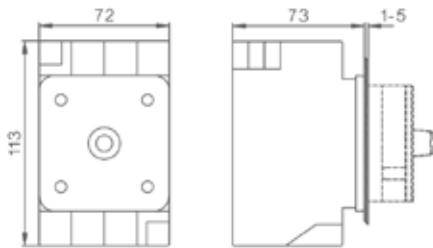

Escutcheon Plate 64
Lever

Lockable Lever

Lockable Rotary

Panel Mounting

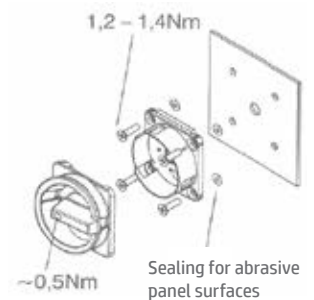
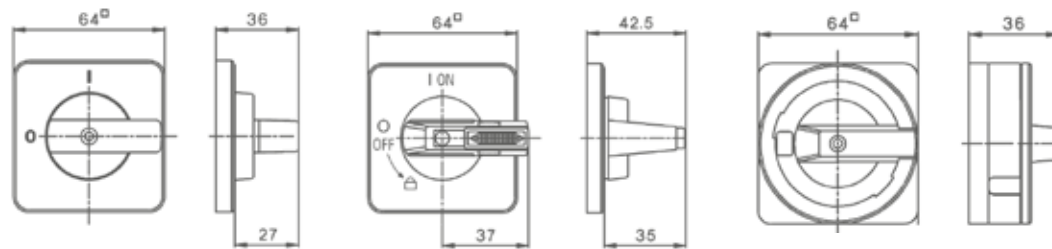

SI16SHM(L) / SI25SHM(L) / SI32SHM(L) / SI38SHM(L)
2

2H, 4

Mounting Hole

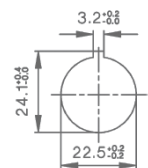
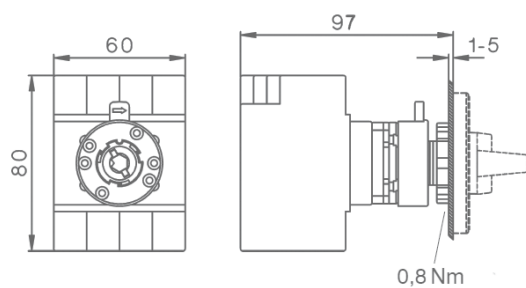
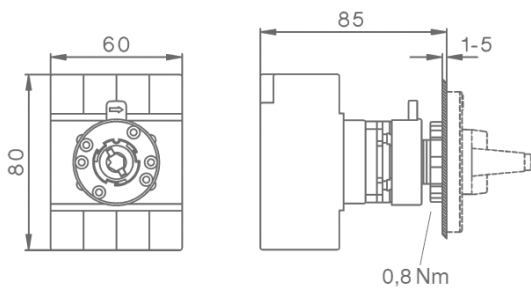

Escutcheon Plate 48
Lever Handle

Lockable Lever

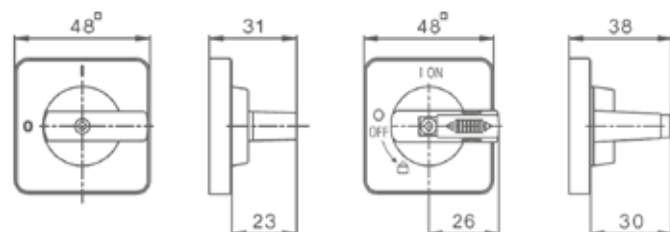

Dimensions (mm) continued

SI16SHM(L) / SI25SHM(L) / SI32SHM(L) / SI38SHM(L)
6, 3H, 8, 4H

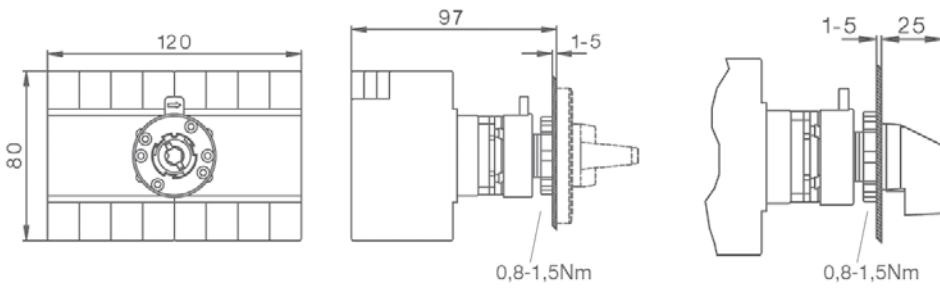

SI16BMDC / SI25BMDC / SI32BMDC / SI38BMDC
2H, 4

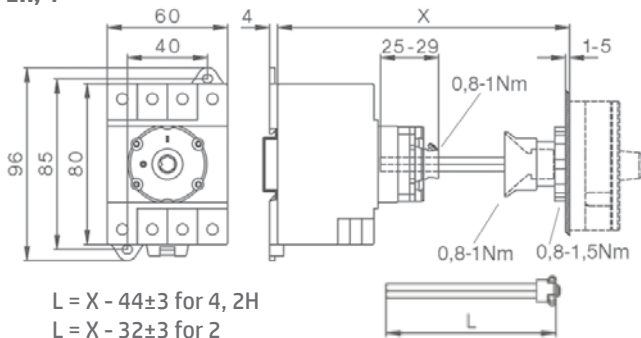

delivered with: 2H, 4
 $X_{max.} = 194$, $L = 150$
 $(X_{min.} = 89)$

delivered with: 2
 $X_{max.} = 182$, $L = 150$
 $(X_{min.} = 77)$

Greater X-Dimensions on request

$L = X - 44 \pm 3$ for 4, 2H
 $L = X - 32 \pm 3$ for 2

SI16BMDC / SI25BMDC / SI32BMDC / SI38BMDC
6, 3H, 8, 4H

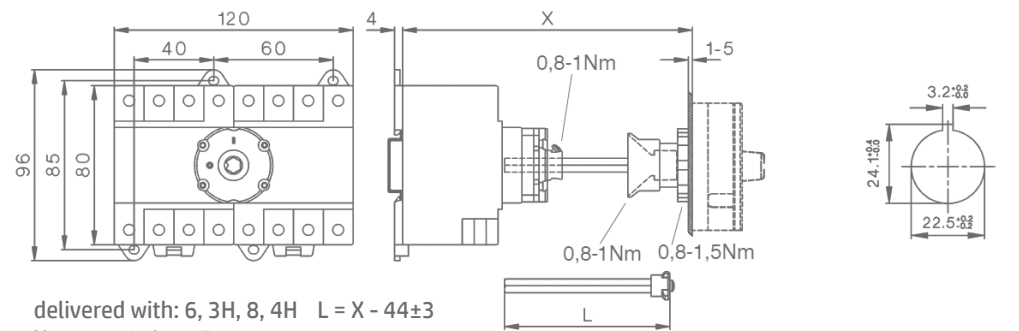

delivered with: 6, 3H, 8, 4H $L = X - 44 \pm 3$
 $X_{max.} = 194$, $L = 150$
 $(X_{min.} = 95)$

SI40BMDC / SI55BMDC / SI65BMDC
2, 2H, 4

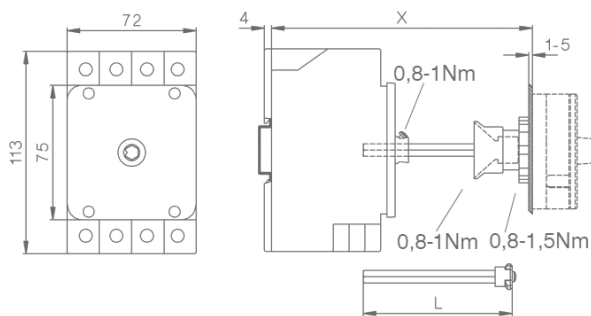

delivered with: 2, 2H, 4 $L = X - 61 \pm 3$
 $X_{max.} = 194$, $L = 133$
 $(X_{min.} = 103)$

SI40BMDC / SI55BMDC / SI65BMDC
6, 3H, 8, 4H

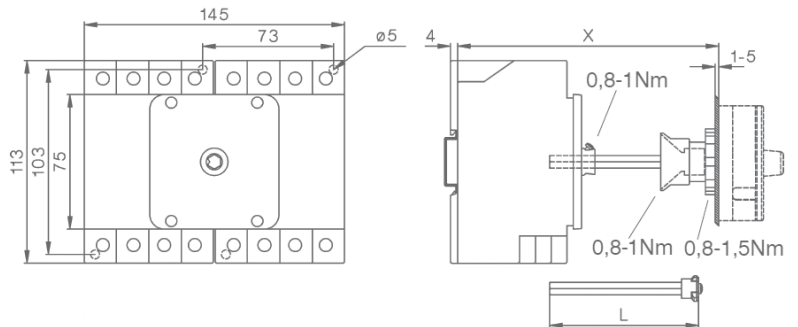

delivered with: 6, 3H, 8, 4H $L = X - 73 \pm 3$
 $X_{max.} = 194$, $L = 121$
 $(X_{min.} = 113)$

Dimensions (mm) continued

SI16DB(L) / SI25DB(L) / SI32DB(L) / SI38DB(L)

2

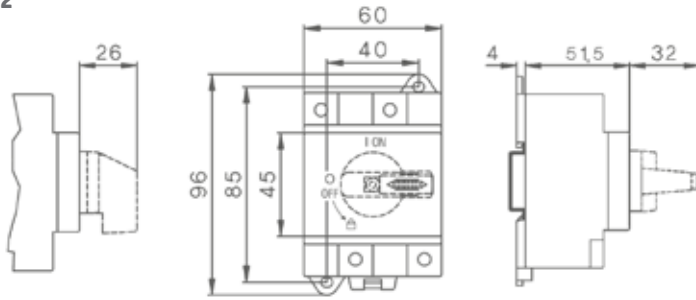

2H, 4

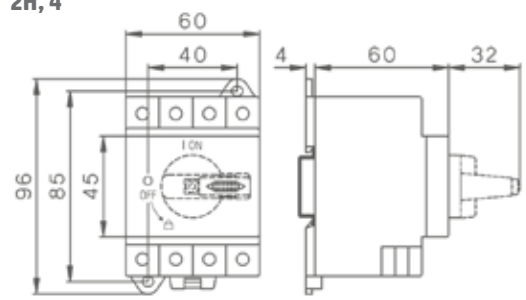

SI40DB(L) / SI55DB(L) / SI65DB(L)

2, 2H, 4

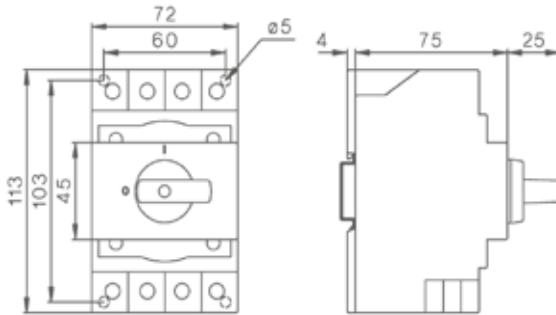

SI40DB(L) / SI55DB(L) / SI65DB(L)

6, 3H, 8, 4H

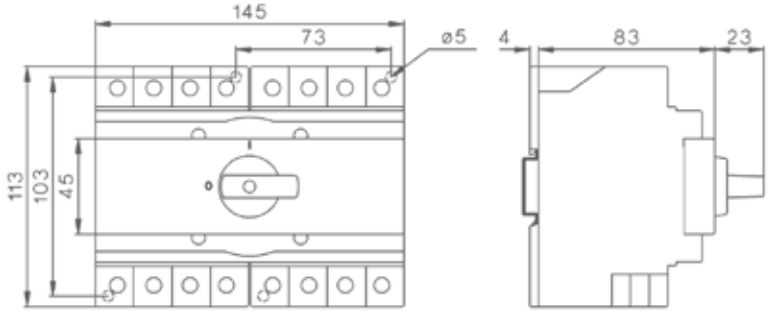

SI16DB(L) / SI25DB(L) / SI32DB(L) / SI38DB(L)

6, 3H, 8, 4H

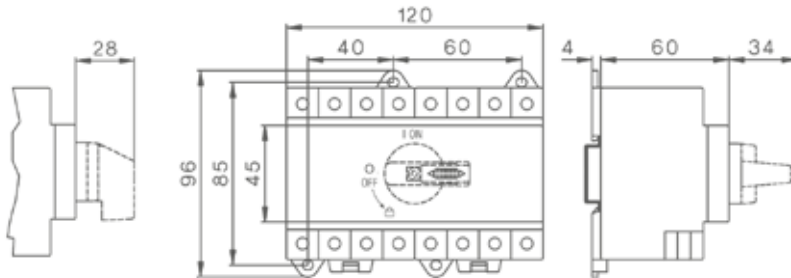

SI.. DBL with low height handle

2-LH

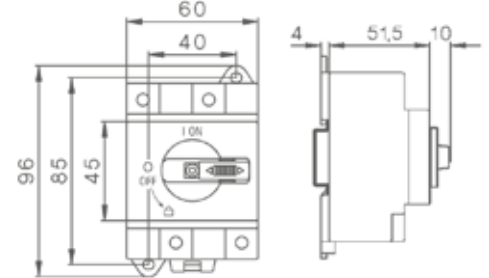

SI16DBL / SI25DBL / SI32DBL / SI38DBL with low height handle

2H-LH, 4-LH

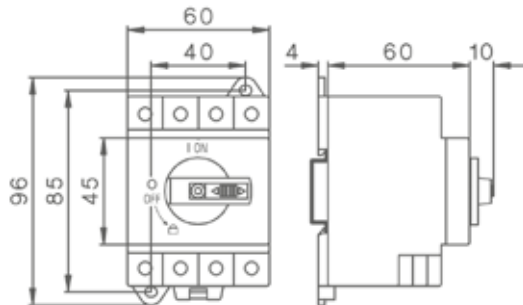

6-LH, 3H-LH, 8-LH, 4H-LH

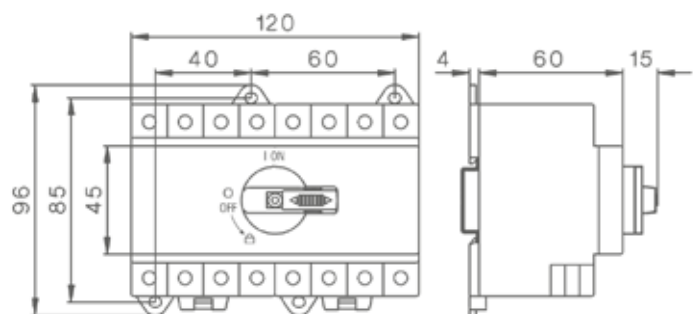

Dimensions (mm) continued

SI16PEL / SI25PEL / SI32PEL / SI38PEL
2, 2H, 4

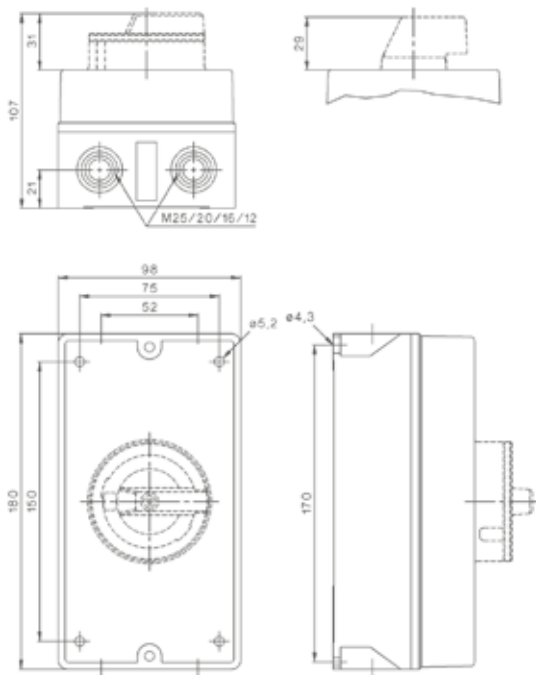

SI16PEL / SI25PEL / SI32PEL / SI38PEL
2, 2H, 4 + M25

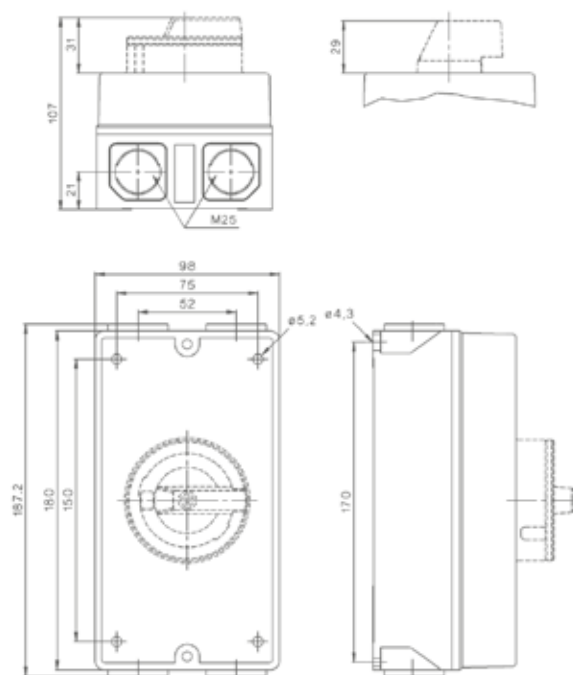

SI16PEL / SI25PEL / SI32PEL / SI38PEL
6, 8, 3H, 4H

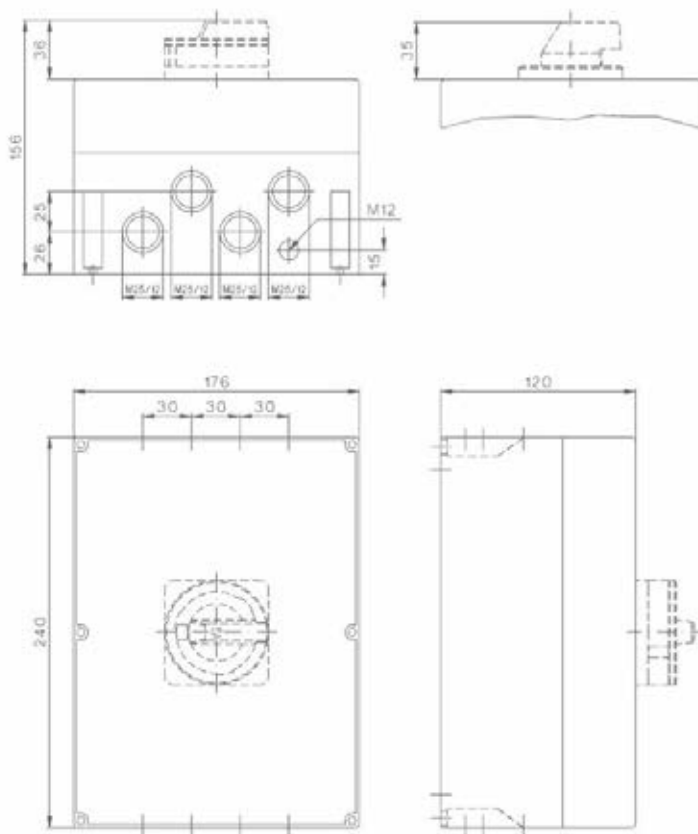

SI40PEL / SI55PEL / SI65PEL
2, 2H, 4

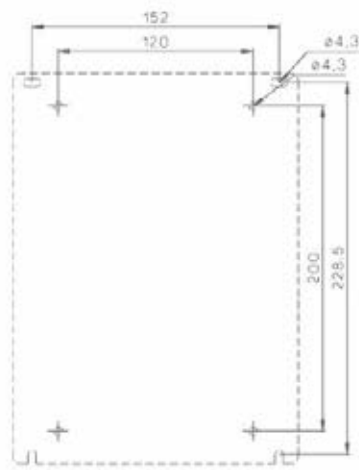

Jumper Applications

SI16.. / SI25.. /
SI32.. / SI38..
2H



2x SIV-B1-1N



2x SIV-B1-1N

SI16.. / SI25.. / SI32..
4T



2x SIV-B1-1N

SI38..
4T



2x SIV-B1-2N

SI16.. / SI25.. /
SI32.. / SI38..
4H



4x SIV-B1-1N

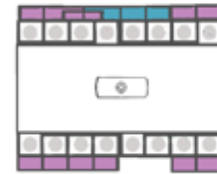

2x SIV-B1-2N
4x SIV-B1-1N

SI40.. / SI55.. / SI65..
2H



2x SIV-B2-1N



2x SIV-B2-1N

SI40.. / SI55.. / SI65..
4T



2x SIV-B2-2N

SI40.. / SI55.. / SI65..
4H



4x SIV-B2-1N

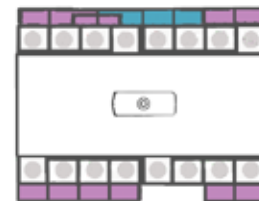

2x SIV-B2-2N
4x SIV-B2-1N

SIM Mini Solar Isolators

Mini TRUE DC Isolators for PV Systems

- Based on market-leading SI series design
- Compact smaller size
- Improved switching capacity
- Extended mounting options
- Guaranteed arc suppression (3ms typical)
- Operator independent switching mechanism
- Knife-edge contacts



The next evolution in DC isolation

When IMO first launched its SI Series DC isolator in 2009, little did it know that the SI would soon become the safety component of choice for many of the largest solar inverter manufacturers and installers around the world. Today, with over 6 million installations and ZERO reported electrical failures*, the SI Series has proved itself more than capable of handling the most demanding DC switching applications.

The NEW SIM represents the next evolution in DC isolation offering all the benefits of its big brother in a compact, high reliability package. With a 35% reduction in cubic volume, reduced front plate “real-estate”, increased ratings and extended mounting options, the SIM is packed with features. Yet it retains the high reliability technology of the current SI Series including knife edge contacts, high speed operator independent switching mechanism and full arc control with guaranteed suppression time.

The NEW SIM represents the next step in meeting the global demand for high reliability, compact and competitive DC safety switching solutions.

Safety as standard

In solar installations, the DC isolator is like a vehicle air-bag. It is rarely called upon but, when required, carries a huge responsibility. So it's good to know that the IMO SI is safeguarding millions of solar installations around the world, without a single reported electrical failure.

Not surprising considering the product carries all the most important approvals including UL508i. In fact the IMO SI range of solar isolators have been tested by some of the most rigorous examiners and OEM manufacturers in the world, passing with flying colours every time.

Smaller... and better

When buying IMO you can be assured of the level of quality and reliability of our products. The SIM is no exception, and just because we have managed to squeeze everything that went into our market-leading SI range into the new SIM's compact body, we haven't compromised on reliability. In fact, we have increased the overall ratings and extended the mounting options.

* Data correct as of November 2018

The OEM's choice

The SI range of isolators was specifically developed for arduous DC disconnect applications and SI isolators are used by many of the largest Solar Inverter manufacturers in the world.

The new SIM range features the same independent trigger ratchet switching mechanism delivering arc extinguishing times of <5ms (3ms typical). Specially designed internal arc cooling chambers control temperature rise and increase safety while knife edge contacts increase reliability and prolong electrical life.

All this along with a 35% reduction in size makes the SIM Series the ideal next generation choice for OEMs globally.

Ordering Variations

Lever Handle Models

Panel Mount (4-screw) 64 x 64 Esc. Plate, Lever Handle, IP66, NEMA 3R	Panel Mount (2-screw) 64 x 64 Esc. Plate, Lever Handle, IP66, NEMA 3R	Single Hole Mount (22.5mm) 48 x 48 Esc. Plate Lever Handle, IP66, NEMA 4X	Single Hole Mount (16mm) No Esc. Plate, Lever Handle, IP66, NEMA 4X	Base Mount (door coupling) 64 x 64 Esc. Plate, Lever Handle, IP66, NEMA 4X	Modular Switch Lever Handle, IP40
SIM**PM64*	SIM**PMT64*	SIM**SHM*	SIM**SHMS*	SIM**BMD64*	SIM**DB*

Lever Handle Models with Lockable OFF

Panel Mount (4-screw) 64 x 64 Esc. Plate, Lockable Lever Handle, IP66, NEMA 3R	Panel Mount (2-screw) 64 x 64 Esc. Plate, Lockable Lever Handle, IP66, NEMA 3R	Single Hole Mount (22.5mm) 48 x 48 Esc. Plate, Lockable Lever Handle, IP66, NEMA 4X	Base Mount (door coupling) 64 x 64 Esc. Plate, Lockable Lever Handle, IP66, NEMA 4X	Modular Switch Lockable Lever Handle, IP40
SIM**PML64*	SIM**PMTL64*	SIM**SHML*	SIM**BMDCL64*	SIM**DBL*

Rotary Handle Models with Lockable OFF

Panel Mount (4-screw) 64 x 64 Lockable Rotary Handle, IP66, NEMA 3R	Base Mount (door coupling) 64 x 64 Lockable Rotary Handle, IP66, NEMA 4X	Enclosed Version Lockable Rotary Handle, IP67, NEMA 4X
SIM**PM64R*	SIM**BMD64R*	SIM**PEL64R*

Part Number Configuration

SIM - **16** - **PM64R** - **2**

Series

SIM Mini DC Solar Isolator (max. 4P)	SIM
SIME Mini DC Solar Isolator	SIME

Switch Rating

16 Amp	16
25 Amp	25
32 Amp	32
38 Amp	38

Number of Poles (see Switching Configurations on p.5)

2	2-Pole
2H	2-Pole 4 Parallel Poles
4	4-Pole
4S	2-Pole 4 Poles in Series (Input Top, Output bottom)
4T	2-Pole 4 Poles in Series (Input & Output bottom)
4B	2-Pole 4 Poles in Series (Input & Output top)
6	6-Pole
8	8-Pole
4H	2-Pole 8 Parallel Poles

Mounting Type

Panel Mount (4-screw), 64 x 64 Escutcheon Plate, Lever Handle	PM64	Base Mount (DIN Rail), 64 x 64 Escutcheon Plate, Lever Handle	BMD64
Panel Mount (4-screw), 64 x 64 Escutcheon Plate, Lockable Lever Handle	PML64	Base Mount (DIN Rail), 64 x 64 Escutcheon Plate, Lockable Lever Handle	BMDCL64
Panel Mount (4-screw), 64 x 64 Lockable Rotary Handle	PM64R	Base Mount (DIN Rail), 64 x 64 Lockable Rotary Handle	BMD64R
Panel Mount (2-screw), 64 x 64 Escutcheon Plate, Lever Handle	PMT64	Base Mount (2 mounting lugs), 64 x 64 Lockable Rotary Handle	BMS64R*
Panel Mount (2-screw), 64 x 64 Escutcheon Plate, Lockable Lever Handle	PMTL64	Modular Switch, Lever Handle	DB
Single Hole (22.5mm) Mount, 48 x 48 Escutcheon Plate, Lever Handle	SHM	Modular Switch, Lockable Lever Handle	DBL
Single Hole (22.5mm) Mount, 48 x 48 Escutcheon Plate, Lockable Lever Handle	SHML	Enclosed Version, Lockable Rotary Handle	PEL64R
Single Hole (16mm) Mount, No Escutcheon Plate, Lever Handle	SHMS		

* SIM only

Switching Configurations

Type	2-pole	2-pole 4 parallel poles	4-pole	4 poles in series Input on top Output bottom	4 poles in series Input and Output bottom	4 poles in series Input and Output on top
SIM(E)16	2	2H	4	4S	4T	4B
SIM(E)25	2	2H	4	4S	4T	4B
SIM(E)32	2	2H	4	4S	4T	4B
SIM(E)38	2	2H	4	4S	4T	4B
Contact Wiring Diagram						
Switching Example						

Type	6-pole	8-pole	2-pole 8 parallel poles
SIME16	6	8	4H
SIME25	6	8	4H
SIME32	6	8	4H
SIME38	6	8	4H
Contacts Wiring Diagram			
Switching example			



Insulated Jumper

for series and parallel switching of contacts

Type	SIM16	SIM25	SIM32	SIM38
4T / 4B	2x SIMV-B1-1N		2x SIMV-B1-2N	
2H	4x SIMV-B1-1N			
4S	1x SIMV-B1-1N & 1x LG11852		1x SIMV-B1-2N & 1x LG11852	

WARNING: Verify that all connections (including bridging link connections) are suitable for the rated current, prepared to ensure only conductive parts are clamped and tightened to the manufacturer's required torque before energisation.

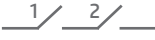
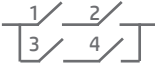
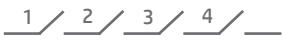
Technical Data for DC according to IEC 60947-3

Type		DC-PV1								DC-PV2			
		500V	600V	700V	800V	900V	1000V	1200V	1500V	500V	600V	800V	1000V
2 poles in series 2 	SIM16 ..	16A	16A	16A	16A	16A	10A	7A	3A	16A	14A	12A	4A
	SIM25 ..	25A	25A	25A	20A	17A	11.5A	8.5A	5A	25A	21A	15A	5A
	SIM32 ..	32A	32A	32A	23A	20A	13A	10A	6A	32A	27A	17A	6A
	SIM38 ..	45A	45A	36A	30A	25A	20A	10A	6A	38A	31A	19A	7A
2 poles in series + 2 parallel 2H 	SIM16 ..	29A	29A	22A	17A	16A	10A	7A	3A	25A	20A	12A	4A
	SIM25 ..	45A	36A	27A	20A	17A	11.5A	8.5A	5A	39A	32A	15A	5A
	SIM32 ..	50A	50A	32A	23A	20A	13A	10A	6A	50A	35A	17A	6A
	SIM38 ..	50A	50A	36A	30A	25A	20A	10A	6A	50A	38A	19A	7A
4 poles in series 4S, 4B, 4T 	SIM16 ..	16A	16A	16A	16A	16A	16A	16A	16A	16A	16A	16A	16A
	SIM25 ..	25A	25A	25A	25A	25A	25A	25A	25A	25A	25A	25A	25A
	SIM32 ..	32A	32A	32A	32A	32A	32A	32A	32A	32A	32A	32A	32A
	SIM38 ..	45A	45A	45A	45A	45A	38A	32A	32A	45A	45A	38A	38A
4 poles in series + 2 parallel 4H 	SIME16 ..	29A	29A	29A	29A	29A	29A	29A	20A	29A	29A	21A	16A
	SIME25 ..	45A	45A	45A	45A	45A	45A	33A	26A	45A	45A	35A	25A
	SIME32 ..	50A	50A	50A	50A	50A	50A	50A	32A	50A	50A	45A	32A
	SIME38 ..	50A	50A	50A	50A	50A	50A	50A	32A	50A	50A	50A	50A

Technical Data for DC according to UL508i

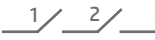
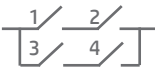
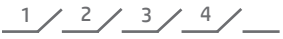
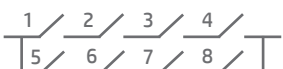
Type		UL508i			
		200V	350V	500V	600V
2 poles in series 2 	SIM16 ..	16A	16A	16A	16A
	SIM25 ..	25A	25A	25A	25A
	SIM32 ..	32A	32A	32A	32A
	SIM38 ..	38A	38A	38A	36A
2 poles in series + 2 parallel 2H 	SIM16 ..	29A	29A	29A	21A
	SIM25 ..	45A	45A	41A	30A
	SIM32 ..	50A	50A	43A	33A
	SIM38 ..	50A	50A	45A	36A
4 poles in series 4S, 4B, 4T 	SIM16 ..	16A	16A	16A	16A
	SIM25 ..	25A	25A	25A	25A
	SIM32 ..	32A	32A	32A	32A
	SIM38 ..	38A	38A	38A	36A
4 poles in series + 2 parallel 4H 	SIME16 ..	29A	29A	29A	21A
	SIME25 ..	45A	45A	45A	45A
	SIME32 ..	50A	50A	50A	50A
	SIME38 ..	50A	50A	50A	50A

Technical Data

Data according to IEC 60947-3, VDE 0660, GB14048.3

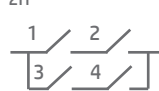
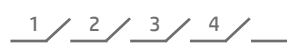
Main Contacts		Type	SIM(E)16	SIM(E)25	SIM(E)32	SIM(E)38	
Rated thermal current I_{the}		A	16	25	32	38	
Rated insulation voltage $U_i^{1)}$		V	1000	1000	1000	1000	
Rated insulation voltage $U_i^{2)}$		V	1500	1500	1500	1500	
Distance of contacts (per pole)		mm	8	8	8	8	
Rated operational current I_e DC21A 	1 pole						
	1						
	300V	A	16	23	27	-	
	400V	A	12	14	16	-	
	500V	A	9	11	13	-	
	600V	A	6	8	10	-	
	700V	A	4.5	6	7.5	-	
	800V	A	3	4	5	-	
	900V	A	2.5	3	4	-	
	1000V	A	1.5	2	2.5	-	
	2 poles in series						
	2						
	500V	A	16	25	32	-	
	600V	A	16	25	32	-	
	700V	A	16	23	27	-	
	800V	A	16	20	-	-	
	900V	A	13	16	-	-	
	1000V	A	9	11	13	-	
	1200V	A	6	8	10	-	
	1500V	A	3	4	5	-	
2 poles in series + 2 poles parallel							
2H							
							
500V	A	29	45	50	-		
600V	A	29	45	50	-		
700V	A	16	23	27	-		
800V	A	16	20	-	-		
900V	A	13	16	-	-		
1000V	A	9	11	13	-		
1200V	A	6	8	10	-		
1500V	A	3	4	5	-		
4 poles in series							
4S, 4B, 4T							
							
500V	A	16	25	32	-		
600V	A	16	25	32	-		
700V	A	16	25	32	-		
800V	A	16	25	32	-		
900V	A	16	25	32	-		
1000V	A	16	25	32	-		
1200V	A	16	25	32	-		
1500V	A	16	20	23	-		
Rated operational current I_e AC21B	2, 4	U_e max. 440V	A	16	25	32	45
	2H	U_e max. 440V	A	29	45	50	-
Rated conditional short circuit current			kA_{eff}	5	5	5	5
Max. fuse size		gL (gG)	A	40	63	80	80
Mechanical life			$\times 10^3$	10	10	10	10
Rated short-time withstand current (1s)	I_{cw}	2, 4	A	800	900	1000	1000
		2H	A	1300	1500	1700	1700
Short circuit making capacity	I_{cm}	2, 4	A	800	900	1000	1000
		2H	A	1300	1500	1700	1700
Maximum cable cross sections (inc. jumper SIMV-B1)							
solid stranded			mm ²	1.5 - 10	4 - 10	4 - 10	4 - 10
flexible			mm ²	1.5 - 6	4 - 6	4 - 6	4 - 6
flexible (+ multicore cable end)			mm ²	1.5 - 6	4 - 6	4 - 6	4 - 6
Size of terminal screw				M3.5 Pz1	M3.5 Pz1	M3.5 Pz1	M3.5 Pz1
Tightening torque			Nm	1.4	1.4	1.4	1.4
2 cables per clamp without jumper SIMV-B1 solid or stranded			mm ²	2 x 0.5mm ² to 2x6mm ²			
Maximum ambient temperature							
Operation	open		°C	-40 to +65			
	enclosed		°C	-40 to +45			
Storage			°C	-50 to +90			
Contact Resistance per pole			mΩ	1.75			

1) Suitable at overvoltage category I to III, pollution degree 3 (standard-industry): $U_{imp} = 8kV$.

2) Suitable at overvoltage category I to III, pollution degree 2 (min.IP55): $U_{imp} = 8kV$.

Technical Data

Data according to IEC 60947-3, VDE 0660, GB14048.3

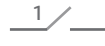
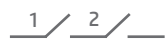
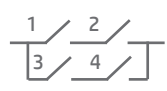
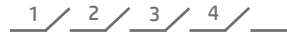

Main Contacts		Type	SIM(E)16	SIM(E)25	SIM(E)32	SIM(E)38			
Rated thermal current I_{the}		A	16	25	32	38			
Rated insulation voltage U_i ¹⁾		V	1000	1000	1000	1000			
Rated insulation voltage U_i ²⁾		V	1500	1500	1500	1500			
Distance of contacts (per pole)		mm	8	8	8	8			
DC21B	1 pole 1 	300V	A	-	-	-	-		
		400V	A	-	-	-	-		
		500V	A	-	-	-	-		
		600V	A	-	-	-	-		
		700V	A	-	-	-	-		
		800V	A	-	-	-	-		
		900V	A	-	-	-	-		
		1000V	A	-	-	-	-		
		2 poles in series 2 		500V	A	16	25	32	45
				600V	A	16	25	32	45
			700V	A	16	25	32	36	
			800V	A	16	20	23	30	
			900V	A	16	17	20	25	
			1000V	A	10	11.5	13	20	
			1200V	A	7	8.5	10	10	
			1500V	A	3	5	6	6	
	2 poles in series + 2 poles parallel 2H 		500V	A	29	45	50	50	
			600V	A	29	45	50	50	
			700V	A	22	27	32	36	
			800V	A	17	20	23	30	
		900V	A	16	17	20	25		
		1000V	A	10	11.5	13	20		
		1200V	A	7	8.5	10	10		
		1500V	A	3	5	6	6		
4 poles in series 4S, 4B, 4T 		500V	A	16	25	32	45		
		600V	A	16	25	32	45		
		700V	A	16	25	32	45		
		800V	A	16	25	32	45		
		900V	A	16	25	32	45		
		1000V	A	16	25	32	38		
		1200V	A	16	25	32	32		
		1500V	A	16	20	32	32		
Rated operational current I_e									
AC21B	2, 4	U_e max. 440V	A	16	25	32	45		
	2H	U_e max. 440V	A	29	45	50	50		

1) Suitable at overvoltage category I to III, pollution degree 3 (standard-industry): $U_{imp} = 8kV$.

2) Suitable at overvoltage category I to III, pollution degree 2 (min.IP55): $U_{imp} = 8kV$.

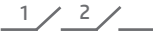
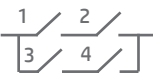
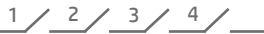

Technical Data continued

Data according to IEC 60947-3, VDE 0660, GB14048.3

Main Contacts	Type	SIM(E)16		SIM(E)25		SIM(E)32		SIM(E)38				
Rated operational current I _e	300V	A	16	16	23	23	27	27	-	27		
	400V	A	14	14	22	18	25	20	-	20		
DC-PV1 1 pole 1	500V	A	10	10	17	12	20	14	-	14		
	600V	A	7	5	12	6	15	8	-	8		
	700V	A	5	1.5	6	2	7.5	3	-	3		
	800V	A	3	1.5	4	2	5	3	-	3		
DC-PV2 1 pole 	900V	A	3	1	3	1.5	4	2	-	2		
	1000V	A	2	1	2	1.5	3	2	-	2		
	2 poles in series		500V	A	16	16	25	25	32	32	45	38
	2		600V	A	16	14	25	21	32	27	45	31
	700V	A	16	13	25	19	32	22	36	25		
	800V	A	16	12	20	15	23	17	30	19		
	900V	A	16	8	17	10	20	12	25	14		
	1000V	A	10	4	11.5	5	13	6	20	7		
	1100V	A	8	3	10	4	-	-	-	-		
	1200V	A	7	2	8.5	3	10	4	10	4		
	1300V	A	6	1.5	7	2	-	-	-	-		
	1400V	A	5	1	6	2	-	-	-	-		
	1500V	A	3	1	5	1.5	6	2	6	2		
	2 poles in series + 2 poles parallel 2H 	500V	A	29	25	45	39	50	50	50	50	
600V		A	29	20	36	32	50	35	50	38		
700V		A	22	13	27	19	32	22	36	25		
800V		A	17	12	20	15	23	17	30	19		
900V		A	16	8	17	10	20	12	25	14		
1000V		A	10	4	11.5	5	13	6	20	7		
1100V		A	8	3	10	4	-	-	-	-		
1200V		A	7	2	8.5	3	10	4	10	4		
1300V		A	6	1.5	7	2	-	-	-	-		
1400V		A	5	1	6	2	-	-	-	-		
4 poles in series 4S, 4B, 4T 	1500V	A	3	1	5	1.5	6	2	6	2		
	500V	A	16	16	25	25	32	32	45	45		
	600V	A	16	16	25	25	32	32	45	45		
	700V	A	16	16	25	25	32	32	45	45		
	800V	A	16	16	25	25	32	32	45	38		
	900V	A	16	16	25	25	32	32	45	38		
	1000V	A	16	16	25	25	32	32	38	38		
	1100V	A	16	16	25	25	-	-	-	-		
	1200V	A	16	13.5	25	21	32	27	32	27		
	1300V	A	16	12	25	19	-	-	-	-		
4 poles in series + 2 parallel 4H 	1400V	A	16	10.5	25	16	-	-	-	-		
	1500V	A	16	9	25	14	32	18	32	18		
	500V	A	29	29	45	45	50	50	50	50		
	600V	A	29	29	45	45	50	50	50	50		
	700V	A	29	25	45	40	50	50	50	50		
	800V	A	29	21	45	35	50	45	50	50		
	900V	A	29	18	45	30	50	37	50	50		
	1000V	A	29	16	45	25	50	32	50	50		
	1100V	A	29	-	-	-	-	-	-	-		
	1200V	A	29	13.5	33	21	50	27	50	27		
1300V	A	29	-	-	-	-	-	-	-			
1400V	A	29	-	-	-	-	-	-	-			
1500V	A	20	9	26	14	32	18	32	18			

Technical Data continued

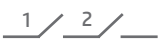
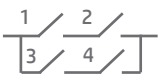
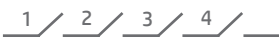
Data according to UL508i  File E362605, CCN: NMSJ and UL60947-1 & UL60947-4-1  File E146487, CCN: NRNT, NRNT7

Main Contacts	Type	SIM(E)16	SIM(E)25	SIM(E)32	SIM(E)38	
Ampere-Rating "General Use"	DC					
1 pole 1 	350V	A	4	5	6	6
	500V	A	4	5	6	6
	600V	A	4	5	6	6
	700V	A	-	-	-	-
	800V	A	-	-	-	-
	900V	A	-	-	-	-
	1000V	A	-	-	-	-
	2 poles in series 2 	350V	A	16	25	32
500V		A	16	25	32	38
600V		A	16	25	32	36
700V		A	-	-	-	-
800V		A	-	-	-	-
900V		A	-	-	-	-
1000V		A	-	-	-	-
2 poles in series + 2 poles parallel 2H 		350V	A	29	45	50
	500V	A	29	38	43	45
	600V	A	21	27	33	36
	700V	A	-	-	-	-
	800V	A	-	-	-	-
	900V	A	-	-	-	-
	1000V	A	-	-	-	-
	4 poles in series 4S, 4B, 4T 	350V	A	16	25	32
500V		A	16	25	32	38
600V		A	16	25	32	36
700V		A	14	20	24.5	24.5
800V		A	12	16	19	19
900V		A	-	-	-	-
1000V		A	-	-	-	-
4 poles in series + 2 parallel 4H 		350V	A	16	25	50
	500V	A	16	25	50	50
	600V	A	16	25	50	50
	700V	A	-	-	-	-
	800V	A	-	-	-	-
	900V	A	-	-	-	-
	1000V	A	-	-	-	-
	Fuse size (RK5) Industrial Control Switch 5kA / 600V	A	40	60	80	80
Maximum cable cross sections solid stranded Size of terminal screw Tightening torque	(including jumper SIMV-B1) AWG AWG lb.inch	16 - 10 20 - 6 M3.5 Pz1 12.4	16 - 10 20 - 6 M3.5 Pz1 12.4	16 - 10 20 - 6 M3.5 Pz1 12.4	16 - 10 20 - 6 M3.5 Pz1 12.4	

Derating Curves for SIM16

Switch SIM(E)16 2 poles all types except PEL64R

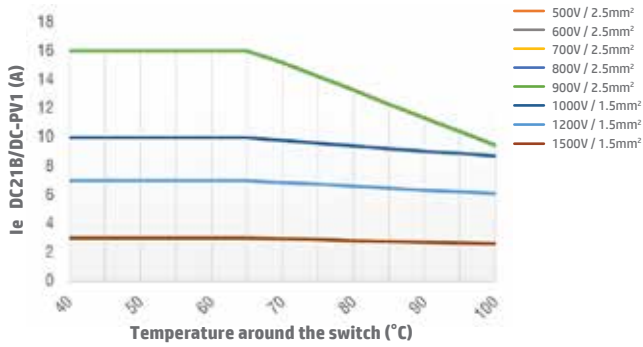

Switch SIM(E)16 2H all types except PEL64R

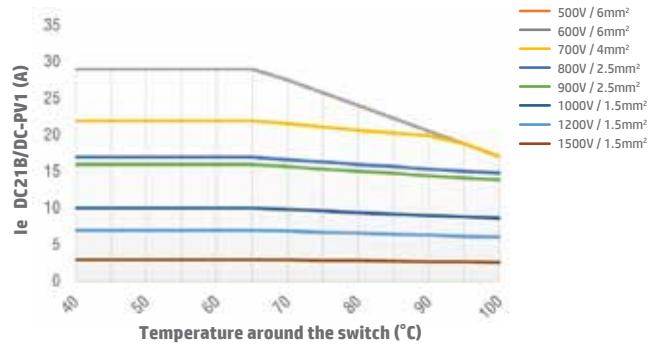

Switch SIM(E)16 4S/4B/4T all types except PEL64R

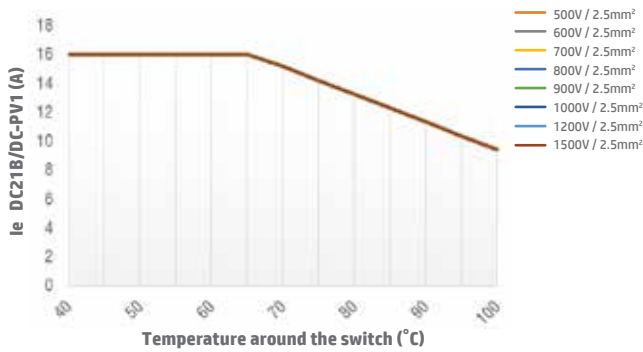

Switch SIM(E)16 2 poles PEL64R type

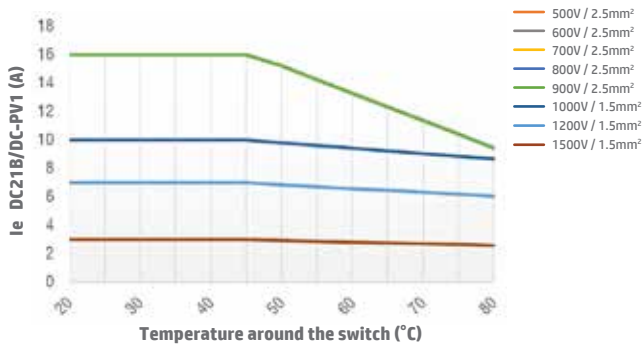

Switch SIM(E)16 2H PEL64R type

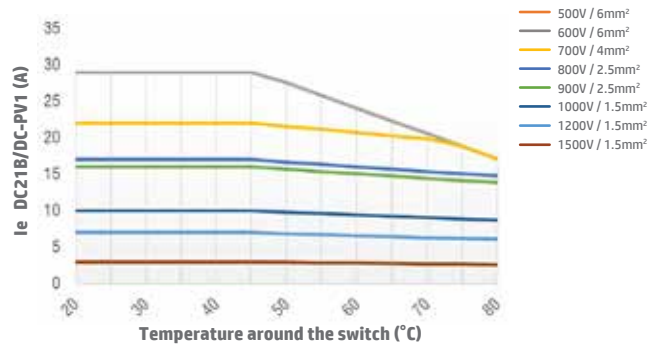

Switch SIM(E)16 4S/4B/4T PEL64R type

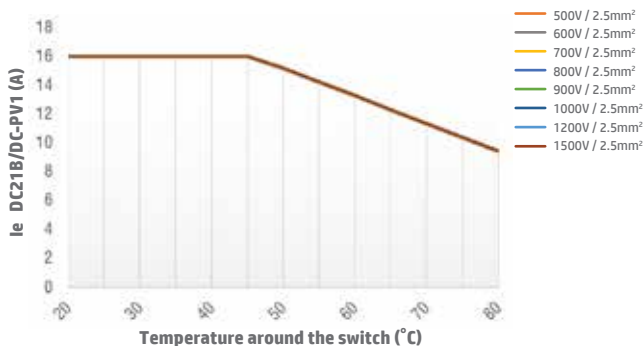

Derating Curves for SIM25

Switch SIM(E)25 2 poles all types except PEL64R

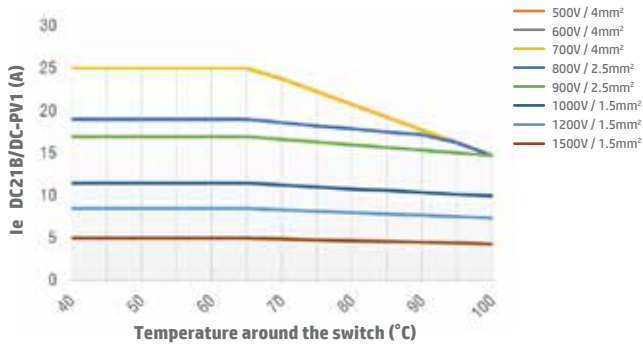

Switch SIM(E)25 2H all types except PEL64R

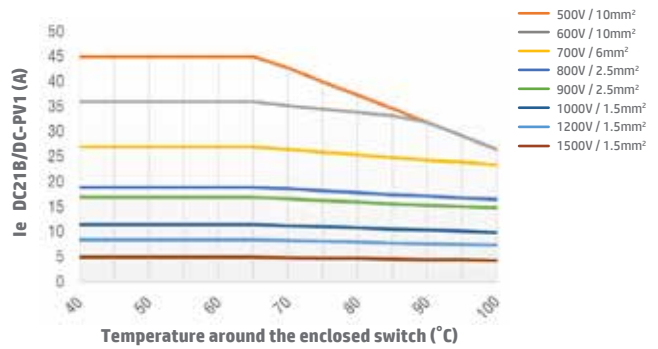

Switch SIM(E)25 4S/4B/4T all types except PEL64R

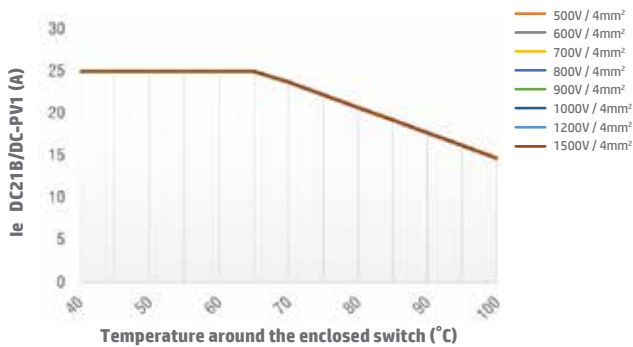

Switch SIM(E)25 2 poles PEL64R type

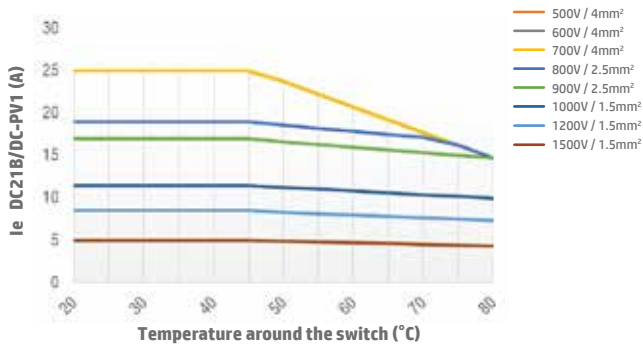

Switch SIM(E)25 2H PEL64R type

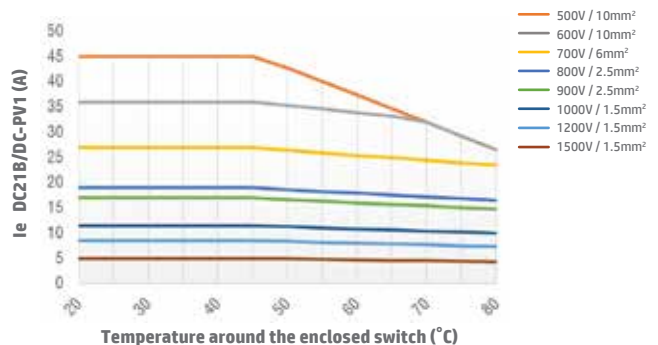

Switch SIM(E)25 4S/4B/4T PEL64R type

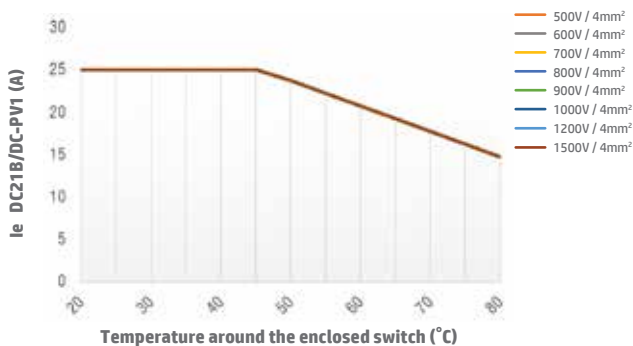

Note: SIM(E)32 & SIM(E)38 ratings available upon request

Handle Options

48 x 48 Lever Handle



IP66 - NEMA 4X

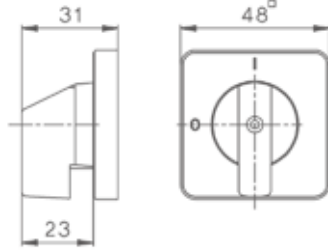

Mounting Hole(s)

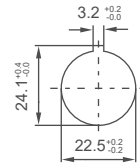

SHM Version

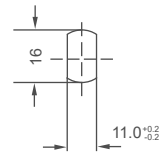

SHMS Version
(No escutcheon plate)

48 x 48 Lever Handle with Lockable OFF



IP66 - NEMA 4X

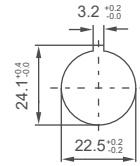
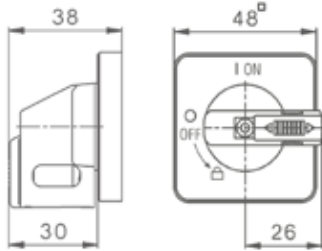

SHML Version

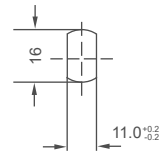

SHMSL Version
(No escutcheon plate)

64 x 64 Lever Handle



IP66 - NEMA 3R

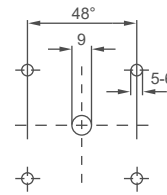
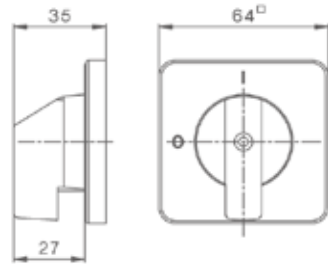

PM Version

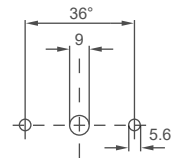

PMT Version

64 x 64 Lever Handle with Lockable OFF



IP66 - NEMA 3R

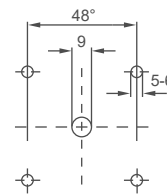
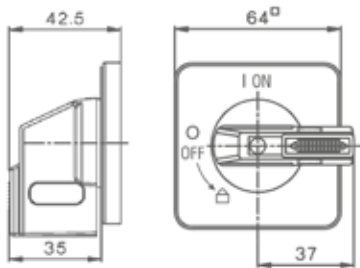

PM Version

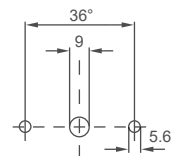

PMT Version

64 x 64 Rotary Handle with Lockable OFF



IP66 - NEMA 4X
(PEL64R version - IP67)

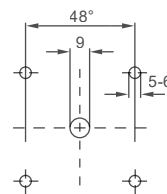
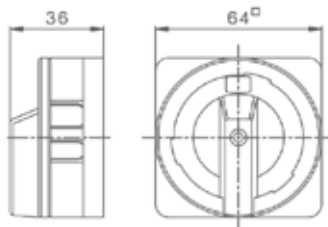

PM Version

Note: BMDC Version
only requires central hole

Dimensions (mm)

Mounting Hole

SIM-PM64-2**
Panel Mounting
64x64 Escutcheon Plate - 2 Pole

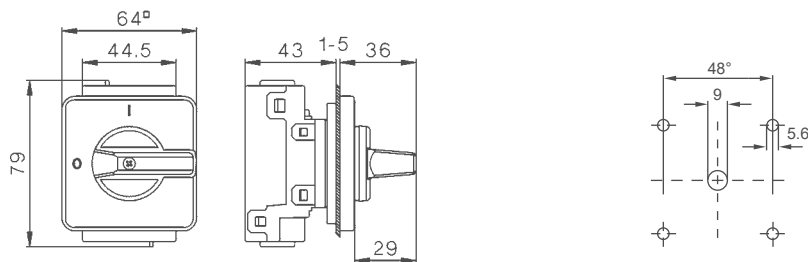

SIM-PM64-4 / SIM**-PM64-2H**
Panel Mounting
64x64 Escutcheon Plate - 4 Pole

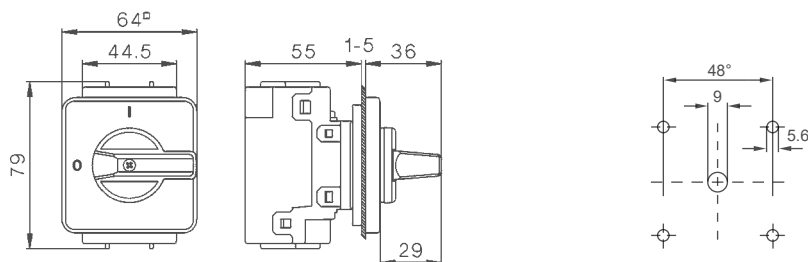

SIM-PMT64-2**
Panel Mounting
64x64 Escutcheon Plate - 2 Pole

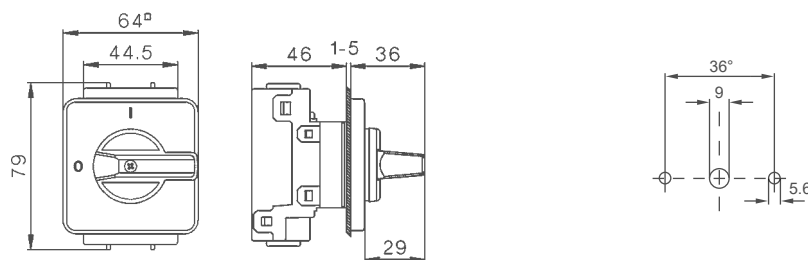

SIM-PMT64-4 / SIM**-PMT64-2H**
Panel Mounting
64x64 Escutcheon Plate - 4 Pole

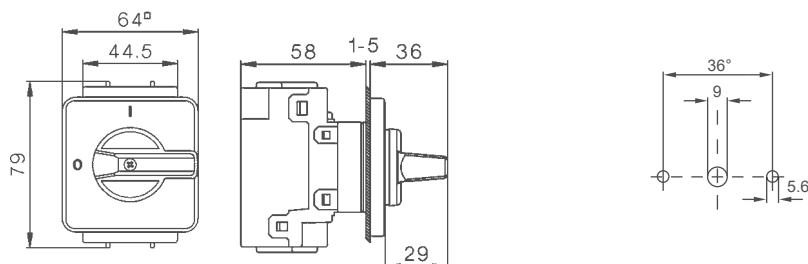

SIM-SHM-2**
Single Hole Mounting
Ø 22.5mm - 2 Pole

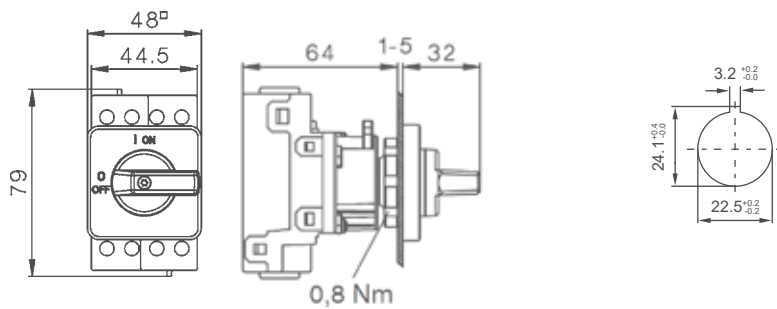

Mounting Hole

SIM-SHM-4 / SIM**-SHM-2H**

Single Hole Mounting
 Ø 22.5mm - 4 Pole

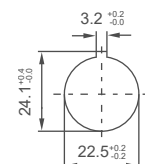
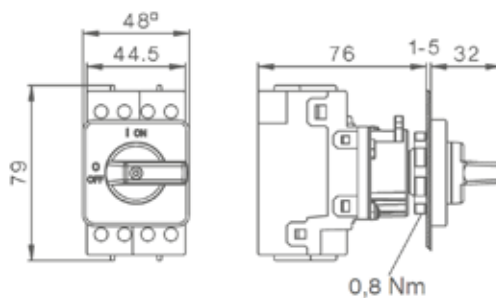

SIM-SHMS-2**

Single Hole Mounting
 Ø 16mm - 2 Pole

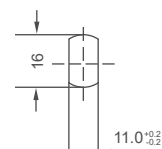
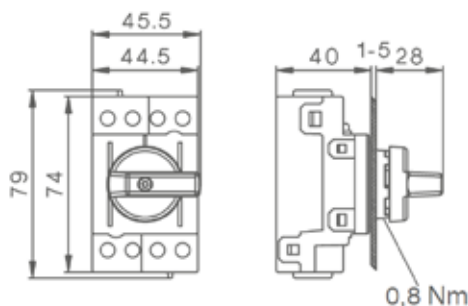

SIM-SHMS-4 / SIM**-SHMS-2H**

Single Hole Mounting
 Ø 16mm - 4 Pole

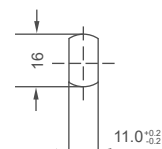
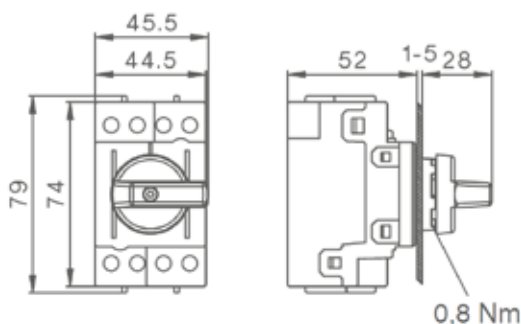

SIM-BMDC64R-2**

Base Mounting with door coupling
 64x64 Escutcheon Plate - 2 Pole

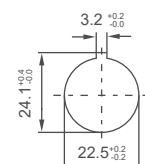
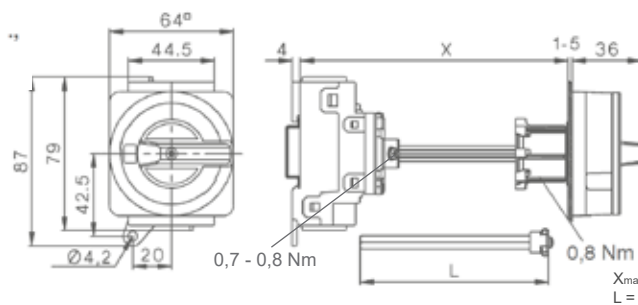

$X_{max} = 182$
 $L = X - 26.5 (\pm 3)$

SIM-BMDC64R-4 / SIM**-BMDC64R-2H**

Base Mounting with door coupling
 64x64 Escutcheon Plate - 4 Pole

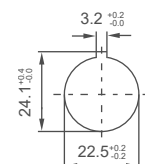
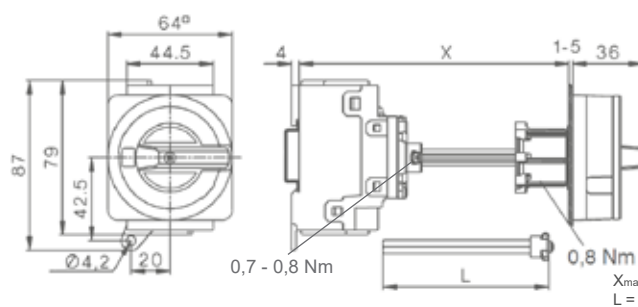

$X_{max} = 194$
 $L = X - 38.5 (\pm 3)$

SIM-BMS64R-4 / SIM**-BMS64R-2H**

Base Mounting with 2 mounting lugs
 64x64 Escutcheon Plate - 4 Pole

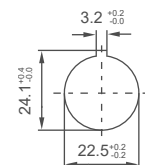
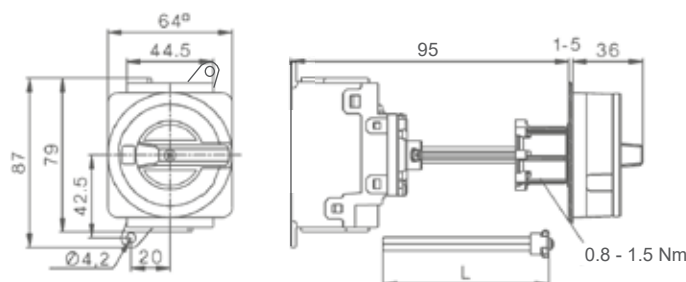

SIM-DB-2**
Modular Switch
2 Pole

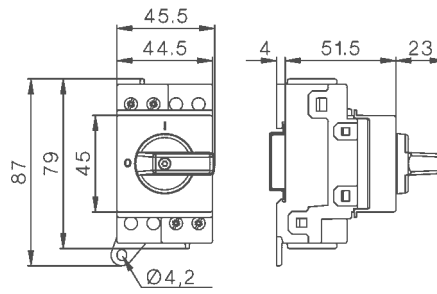

SIM-DB-4 / SIM**-DB-2H**
Modular Switch
4 Pole

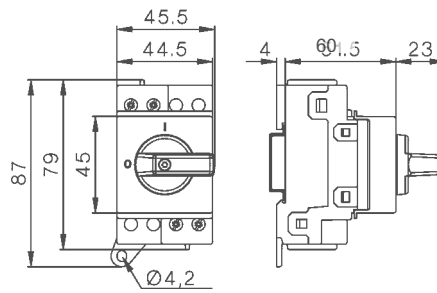

SIM-DBL-2**
Lockable Modular Switch
2 Pole

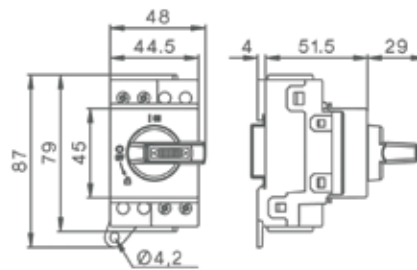

SIM-DBL-4 / SIM**-DBL-2H**
Lockable Modular Switch
4 Pole

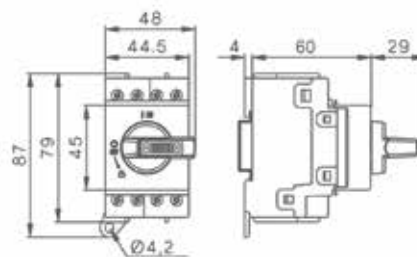

SIM-PEL64R-***
Plastic Enclosure

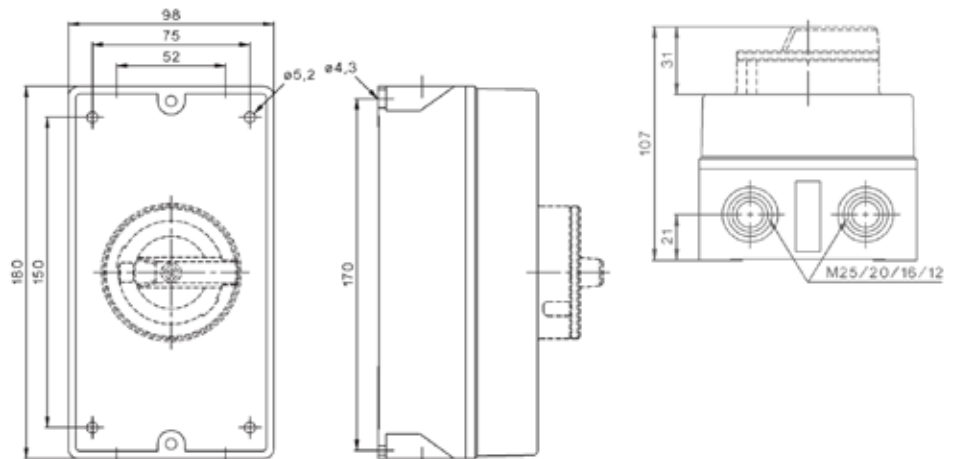

DC Isolator Distribution/String Boxes

- 4 to 48 poles
- High thermal stability - ASA plastic
- Transparent door
- UV stabilized
- IP65 rating - Inside / Outside use
- Earth & neutral bars included
- Suitable for Photovoltaic applications
- Optional Key Lock (E-Lock)



Technical Data

Protection class	IP65	Temperature range	-25°C to 60°C
Isolation class	II	Colour	RAL 7035
Impact kit	IK07	IEC capability	60670-25

Type	Description	Number of terminals PE/N	Dimensions H x W x D (mm)
E-04W	4 Module Enclosure	4/4	201 x 128 x 120
E-08W	8 Module Enclosure	8/8	201 x 202 x 120
E-12W	12 Module Enclosure	10/10	259 x 319 x 144
E-24W	24 Module Enclosure	13/13	384 x 319 x 144
E-36W	36 Module Enclosure	15/15	534 x 319 x 144
E-48W	48 Module Enclosure	20/20	664 x 319 x 141

Type	Cable Entries
E-04W	4 x M20 4 x M25/M32
E-08W	8 x M20 6 x M25 /M32
E-12W	12 x M20 10 x M25/M32 4 x M32/M40 2 x side knockout 90 x 37mm
E-24W	12 x M20 10 x M25/M32 4 x M32/M40 4 x side knockout 90 x 37mm
E-36W	12 x M20 10 x M25/M32 4 x M32/M40 6 x side knockout 90 x 37mm
E-48W	12 x M20 10 x M25/M32 4 x M32/M40 6 x side knockout 90 x 37mm

Step 1 - Select your box:



Step 2 - Select your isolator:



Step 3 - Select your accessories:

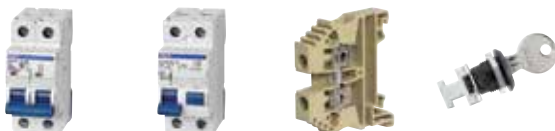

=



Enclosed AC Isolators - PE69

- 3, 4, 6 and 8 pole versions available
- On load 20A - 100A
- Red/Yellow
- 3 Padlock positions
- IP65
- IP66 taller enclosure available
- Aux. Contacts available



Part number	Number of poles	Rating @ 3~400V			
		AC21/Amps	AC3/kW	AC23/Amps	AC23/kW
PE69-3020	3	20	5.5	16	7.5
PE69-3025	3	25	7.5	20	10
PE69-3032	3	32	11	25	12.5
PE69-3040	3	40	15	32	16
PE69-3063	3	63	18.5	45	22
PE69-3080	3	80	18.5	45	22
PE69-30100	3	100	30	72	37
PE69-4020	4	20	5.5	16	7.5
PE69-4025	4	25	7.5	20	10
PE69-4032	4	32	11	25	12.5
PE69-4040	4	40	15	32	16
PE69-4063	4	63	18.5	45	22
PE69-4080	4	80	18.5	45	22
PE69-40100	4	100	30	72	37
PE69-6020	6	20	5.5	16	7.5
PE69-6025	6	25	7.5	20	10
PE69-6032	6	32	11	25	12.5
PE69-6060	6	40	15	32	16
PE69-6063	6	63	18.5	45	22
PE69-6080	6	80	18.5	45	22
PE69-8020	8	20	5.5	16	7.5
PE69-8025	8	25	7.5	20	10
PE69-8032	8	32	11	25	12.5
PE69-8080	8	40	15	32	16
PE69-8063	8	63	18.5	45	22
PE69-8080	8	80	18.5	45	22

Dimensions (mm)

Type	Pole	A	B	C	D1	E	F	H
PE69..20-40	3, 4	130	98	120	2x25.5/20,5	75	150	76
PE69..63-100	3, 4	200	140	188.5	40.5/32.5 + 16.5	100	160	86
PE69..20-40	6	200	140	188.5	40.5/32.5 + 16.5	100	160	86
PE69..20-40	8	240	176	228.5	40.5/32.5	120	200	120
PE69..63-80	6, 8	240	176	228.5	40.5/32.5	120	200	120

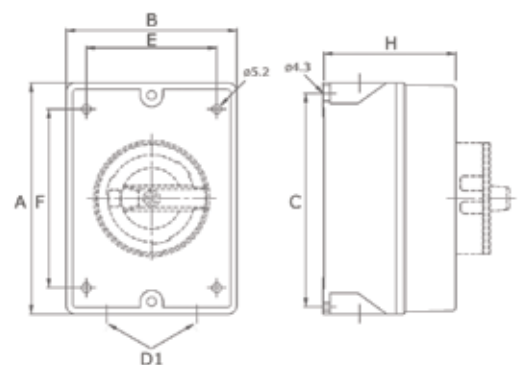

FireRaptor Solar Panel Rapid Shutdown

- Manual Panel Shutdown to 0V Operated from Ground Level
- Automatic Panel Shutdown to 0V at >85°C (185°F) Temperature
- Automatic Panel Shutdown to 0V on External Power Loss
- Hardwire or Mobile Communication Alarm Signalling
- Compliant with NEC 2017 and NEC 2020
- Suitable for New Installations or Retro-Fit



FireRaptor Overview

The IMO FireRaptor provides three forms of Solar Panel Rapid Shutdown to ZERO VOLTS in case of fire or other emergency:

• MANUAL EMERGENCY SHUTDOWN

Manual shutdown is operated via an Emergency Rapid Shutdown Switch utilising a typical “one push” large emergency push button. The switch can be conveniently located anywhere for emergency access and is supplied with a 24VDC power supply to interface with the FireRaptor units.

• AUTOMATIC EMERGENCY TEMPERATURE SHUTDOWN

Automatic shutdown occurs via the temperature sensor onboard the FireRaptor detecting an ambient temperature rise in excess of 85°C (185°F). In the event that the temperature exceeds 85°C (185°F) the FireRaptor will act to shut-down the PV panels as follows:-

FRS-01 - Shuts down the panels connected to the individual FireRaptor sensing the temperature rise above 85°C (185°F). The FireRaptor will re-engage the panels if the temperature drops back below 85°C (185°F) provided it does not exceed 92°C (198°F), in which case a manual reset of the Emergency Switch is required.

FRS-02 - Shuts down the entire string in which the individual FireRaptor sensing the temperature rise above 92°C (198°F) is connected. If this occurs a signal is sent to the Emergency Switch and resetting of the Emergency Switch is then required by a professional installer. The Emergency Switch can be configured to provide connection to the building’s central alarm system or notification via mobile communication (SMS, email etc.).

• AUTOMATIC EMERGENCY EXTERNAL POWER LOSS SHUTDOWN

Disconnection of the external AC supply, by whatever means, causes automatic remote operation of the Emergency Rapid Shutdown Switch.

The FireRaptor can be installed without any set-up and with any string inverter as its functionality is completely independent. “Plug & Play” style installation using industry standard connectors is easy, whether fitted to new installs or retro-fitted to existing projects to upgrade fire safety functionality.

The FireRaptor meets the current requirements of



Ordering Information

Part Number	Description
FRS-01	FireRaptor Rapid Shutdown Unit - suitable for connection to two solar panels
FRS-02	FireRaptor Monitored Rapid Shutdown Unit - suitable for connection to two solar panels
FRS-ESW1	Emergency Rapid Shutdown Switch IP66 (for FRS-01) - includes 24VDC power supply
FRS-ESW1-K	Emergency Rapid Shutdown Switch IP66 (for FRS-01) with Key Lock - includes 24VDC power supply
FRS-ESW2	Emergency Rapid Shutdown Switch IP66 (for FRS-02) - includes 24VDC power supply
FRS-ESW2-K	Emergency Rapid Shutdown Switch IP66 (for FRS-02) with Key Lock - includes 24VDC power supply
FRS-SIGCAB1.8-F	1.8m (70”) Signal Cable terminated at one end with Tyco female connector for use at end of PV String

Emergency Shutdown Switch

The Emergency Shutdown Switch for both the FRS-01 and the FRS-02 is supplied with a 24VDC power supply suitable for up to 40 panel operation. It is available with either a “twist-to-release” pushbutton or keylock pushbutton, both with LED indicator to signal FireRaptor supply status (ON indicates the supply is live).

For larger installations, the Emergency Shutdown Switch is available in custom format with:

- Larger power supply options for increased number of panels (FRS-01 & FRS-02)
- Multi connection terminals for increased number of strings (FRS-01 & FRS-02)
- Temperature monitoring unit with hardwire or mobile communication alarm signalling (FRS-02)

Contact IMO for further information on any of these options.



Technical Specification

Shutdown Control Cable	2x1mm ² cable + Tyco SuperSeal 2-pole connector
Panel & String Cable	4mm ² DC rated cable + MC4 type connector
DC Power Supply	24VDC suitable for up to 20 FireRaptor units (40 panels) - Input 90-264VAC
Maximum Input Power	700W (350W per panel)
Maximum Input Voltage	150V (75V per panel)
Maximum Input Current	12A
Maximum System Voltage	1500V
Input Protection	Over voltage & transient voltage suppression
Maximum Output Current	12A (99.5% efficiency)
Dielectric Strength	1500VAC for 1 minute
Maximum Output Voltage	150V (75V per panel)
Output Protection	Over voltage, over current & transient voltage suppression
Ambient Operating Temperature	-30°C (-22°F) to +95°C (203°F)
IP Class Protection	FireRaptor - IP68 (designed to comply with NEMA 4X), Emergency Switch - IP66 (designed to comply with NEMA 3R)
Casing	FireRaptor - Flame retardant Polycarbonate - UL94-V0, Emergency Switch - Flame retardant ABS - UL94-HB
Weight (without cables)	300g (10.6oz.)
Panel Cable Length	120mm (4 ¹ / ₁₆ "
String & Control Cable Length	1800mm (70 ⁷ / ₈ "
Standard Compliance	EN61000, EN61646, EN61215, IEC 62716 draft C (NH ₃ resistant), VDE-AR-E 2100-712, BS7671-712

Dimensions (mm)

Tolerance ±0.5mm

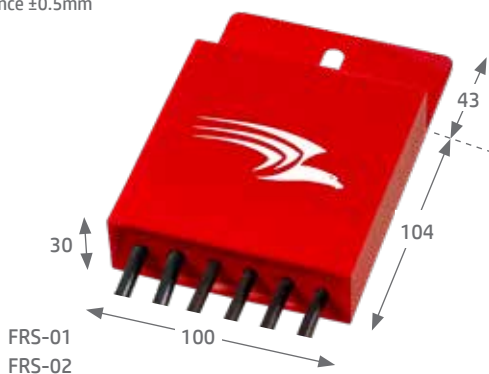

Solar Tracking & Measurement Controller

- Out-of-the-box solution
- Easy to set up
- Flexibility to adapt to any installation



Solar Cube Overview

The IMO Solar Cube has been developed as a ground breaking, easy to set up solar tracking and measurement controller with the flexibility to adapt to any installation.

The Solar Cube is an off the shelf controller designed for use on either one or two axis solar panel installations to track the sun's movement and provide optimum panel (or array) positioning. The sun's position is calculated using the local time and date comparing this with the longitude and latitude location of the solar array. From this data the Solar Cube calculates the 'zenith angle' and the 'azimuth angle', which together exactly specify the position of the sun in the sky to within 0.01°.

To position the array the Solar Cube uses feedback from an electronic compass device connected via RS232 or RS485 which then activates the solar array's actuators until the correct position is reached. The compass is mounted directly on the array frame to give accurate positioning information.

With the option of GPS positioning or manual inputting of the array's location, the Solar Cube is easy to setup anywhere in the world. The Solar Cube is a competitive solution for controlling each array or it can be configured to control up to 4 arrays from one controller providing additional savings. Options for feedback and control from a single control station or via a web server are also available.

Solar Cube also offers data logging facilities using its own internal Micro SD card. Power output can be logged continually to produce daily, monthly and yearly figures. Revenues can be calculated along with CO₂ reduction figures.

Exact Solar Tracking

The sun's position calculation depends upon the current time and date as well as longitude and latitude location of the solar array. The results of this calculation are the 'zenith angle' and the 'azimuth angle', which together exactly specify the position of the sun in the sky.

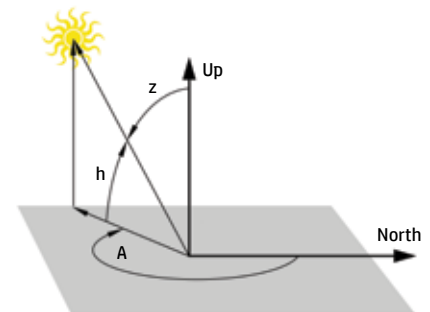

h - elevation angle, measured up from the horizon

z - zenith angle, measured from vertical

A - azimuth angle, measured clockwise from north

Data Logging Facility

Solar Cube also offers data logging facilities using its own internal MicroSD card. Power output can be logged continually to produce daily, monthly and annual figures. Revenues can be calculated along with CO₂ avoidance figures.



Create MS Excel compatible files, backup/restore user programs and change recipe templates.

Access the data remotely using IMO i3-Transfer software. Copy, paste and delete files through Serial or GSM connections, or through the IMO iConnect.

Automate the file transfer process through powerful scripting.

Solar Cube Key Features

- 3.5" Monochrome Touch Screen
- 5 Pre-programmed function keys
- Built-in sun positioning algorithm
- 3D Compass input for accurate positioning
- Automatic location and clock updates with GPS
- MicroSD card for data logging
- Password security for all settings
- Error based adjustment with configurable error values for each axis
- Configurable minimum and maximum adjustment angles
- Configurable safety cut-out system
- Configurable twilight settings (returns to morning position automatically)
- Single Axis supports Azimuth or Zenith tracking
- Supports custom inverter serial communications
- GPRS and Ethernet Remote Access options available
- Emergency Stop input
- Manual Jog function
- Manual Override key
- Optional Ice and Wind Sensor inputs
- Four motor outputs (For 2 Axis Control)
- Limit Switch inputs for safety cut out
- Optional Washer Control output
- Analog input for power output measurement (CT Connection)
- Optional analog input for light level sensing
- IP65 (NEMA4) CE, cUL, UL
- 10-30VDC supply

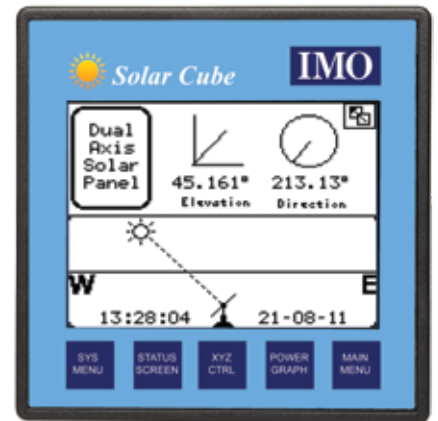
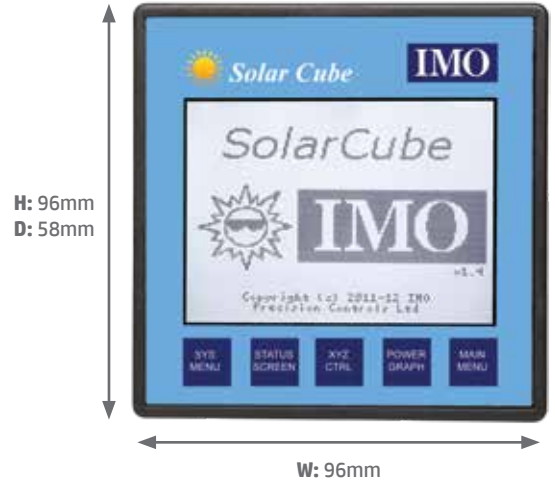

Solar Cube Data Logging

- Total kWh produced to date
- Total kWh produced today
- Current Power Output graph (kW against time)
- Yesterday's Power Output graph
- Yield Values for last 31 days (kWh against days)
- Yield Values for last 12 months (kWh against months)
- Specific Annual Yield

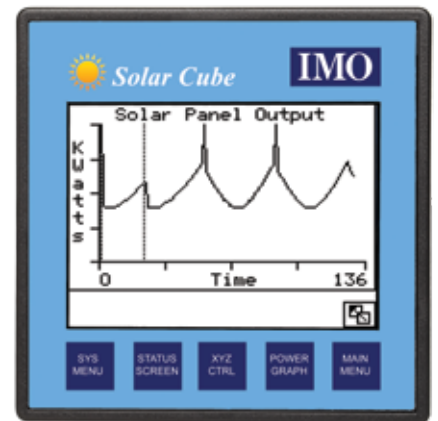

Ordering Information

Single Array

Part Number	Description
SOLARCUBE-1A	Single Array Solar Tracker, 1 or 2 axis configurable
COMPASS-485	3D Positional Compass
OEM GPS RECEIVER	RS232 GPS Receiver



Four Array



Part Number	Description
SOLARCUBE-4A	Four Array Solar Tracker, 1 or 2 axis configurable
SMT-CD-R20-V3 (x3)	Slave Array I/O Repeater
COMPASS-485 (x4)	3D Positional Compass
OEM GPS RECEIVER	RS232 GPS Receiver

Note: Above configuration can be used for each group of 4 Arrays. Where a large number of Arrays need linking a Master Control option is available, call IMO for details.

Solar Relays



Model	DYA	PHY	PEY
			
Features	<ul style="list-style-type: none"> - High voltage direct current relay - 10A, 20A, 40A, 80A, 120A, 200A, 300A switch capability - 10A, 20A, 40A: No specific polarity requirements for connection - Switching power up to 750kW - 2.5kV dielectric strength (between coil & contacts) 	<ul style="list-style-type: none"> - 30A switching capability - 4kV dielectric strength - Class F insulation - 3.00mm contact gap 	<ul style="list-style-type: none"> - 30A switching capability - 4kV dielectric strength - Class F insulation - 3.0mm contact gap
Contact Form	1A	1A, 2A	1A, 2A
Contact Material	Alloy	AgSnO ₂	AgSnO ₂
Max. Switching Voltage	750VDC	277VAC	277VAC
Max. Switching Power	30-750kW	8310VA / 6925VA	8310VA / 6925VA
Rated Load (Resistive Load)	10A 450VDC - 300A 450VDC	1A: 30A 240VAC/30A 277VAC 2A: 25A 240VAC/25A 277VAC	1A: 30A 240VAC/30A 277VAC 2A: 25A 240VAC/25A 277VAC
Rated Voltage	12, 24VDC	6 to 220/240VAC, 3 to 200VDC	6 to 220/240VAC, 3 to 200VDC
Ambient Temperature	-40°C to + 85°C	-55°C to + 70°C	-55°C to + 70°C
Mechanical Life (min.)	2 x 10 ⁵ ops	1 x 10 ⁷ ops	1 x 10 ⁷ ops
Electric Life (min.)	Product Dependant	1 x 10 ⁵ ops	1 x 10 ⁵ ops
Terminal Type	QC, Screw	PCB, QC	Screw

Model	PRW	PRR	PQY
			
Features	<ul style="list-style-type: none"> - 31A switching capability - Applicable to inverter used for photovoltaic power generation systems - Ideal for UPS - 1.5mm contact gap - Clearance between contact & coil is greater than 6.4mm - Creepage distance > 8mm 	<ul style="list-style-type: none"> - 10A switching capability - 5kV dielectric strength - 1.5mm contact gap - Sealed and dust protected versions available 	<ul style="list-style-type: none"> - 10A switching capability - 1.5kV dielectric strength - 2.00mm contact gap - Plug-in and PCB versions available
Contact Form	1A	2A	2C
Contact Material	AgSnO ₂	AgSnO ₂	AgCe
Max. Switching Voltage	277VAC	30VDC / 250VAC	30VDC / 250VAC
Max. Switching Power	7750VA	240W / 2500VA	300W / 2500VA
Rated Load (Resistive Load)	Resistive: 26A 250VAC Inductive: 31A 250VAC	10A 250VAC / 8A 30VDC	10A 30VDC / 250VAC
Rated Voltage	9 to 24VDC	3 to 60VDC	6 to 240VAC, 5 to 220VDC
Ambient Temperature	-40°C to + 85°C	-40°C to + 85°C	-40°C to + 70°C
Mechanical Life (min.)	1 x 10 ⁶ ops	5 x 10 ⁵ ops	1 x 10 ⁷ ops
Electric Life (min.)	3 x 10 ⁴ ops	1 x 10 ⁵ ops	1 x 10 ⁵ ops
Terminal Type	PCB, QC	PCB	PCB, QC

PV Rated DIN Rail Terminals

- 1000V Rated up to 232A
- Up to 95mm² wiring capacity
- UL94-V0 Materials
- Various colours available
- Labelling options
- UR/cUR approved (E244285)

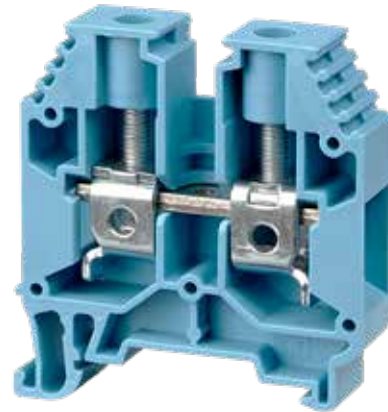

General Product Information	ER16V	ER35PV	ER50V	ER70V	ER70PV
Insulating material	PA 66	PA 66	PA 66	PA 66	PA 66
Inflammability class acc. to UL 94	V0	V0	V0	V0	V0
Dimensions					
Width	12 mm	16 mm	20 mm	22 mm	22 mm
Length	50 mm	52.8 mm	80 mm	74.0 mm	80.0 mm
Height (MR 35x7,5)	55.5mm	58.7 mm	84.7mm	67.5 mm	88.7 mm
IEC Technical Data					
Nominal Voltage	1000 V	1000 V	1000 V	750 V	1000 V
Nominal Current	76 A	115 A	150 A	192 A	232 A
Wire Cross Section	16 mm ²	35 mm ²	50 mm ²	70 mm ²	70 mm ²
UR / cUR Technical Data					
Nominal Voltage	1000 V	1000 V	1000 V	1000 V	1000 V
Nominal Current	85 A	115 A	150 A	175 A	175 A
Wire Cross Section	12 - 4 AWG	12-2 AWG	6 - 1/0 AWG	6-2/0 AWG	6-2/0 AWG
Connection Data					
Minimum solid strand cross section	2.5 mm ²	1.5 mm ²	16 mm ²	10 mm ²	25 mm ²
Maximum solid Strand cross section	25 mm ²	35 mm ²	70 mm ²	70 mm ²	95 mm ²
Minimum fine Strand cross section	4 mm ²	1.5 mm ²	16 mm ²	16 mm ²	35 mm ²
Maximum fine strand cross section	25 mm ²	35 mm ²	50 mm ²	70 mm ²	95 mm ²
AWG Conductor Range	12 - 4	12-2	6 - 1/0	6 - 2/0	6 - 2/0
Connection Type	screw (1,0x5,5)	screw (1.2x6,5)	hexagonal socket screw S5 (DIN 6911)	hexagonal socket screw S6 (DIN 6911)	hexagonal socket screw S6 (DIN 6911)
Insulation Stripping length	16 mm	18 mm	24 mm	24 mm	24 mm
Tightening torque	1,2 - 2,0 Nm	2,5 - 3,5 Nm	6,0 - 10 Nm	6,0 - 12 Nm	6,0 - 12 Nm

IMO Worldwide Offices

IMO Precision Controls Limited

The Interchange
Frobisher Way
Hatfield, Herts AL10 9TG
United Kingdom

Tel: 01707 414 444

Email: imo@imopc.com
Web: www.imopc.com

IMO Jeambrun Automation SAS

Parc de la Broye
14 rue du Chafour
59710 ENNEVELIN
France

Tel: 0800 912 712 (n° gratuit)

Email: imo-fr@imopc.com
Web: www.imojeambrun.fr

IMO Automazione

Via Belfiore 10,
50144 Firenze (FI)
Italia

Tel: 800 930 872 (toll free)

Email: imo-it@imopc.com
Web: www.imopc.it

IMO Canada

1B-701 Rossland Road East
Suite #608
Whitby, Ontario L1N 9K3
Canada

Tel: 416 639 0709

Email: sales-ca@imopc.com
Web: www.imopc.com

IMO Automation LLC

Steeplechase Industrial Park
Suite E, 5845 Steeplechase Blvd
Cumming, GA 30040
USA

Tel: 404 476 8810

Email: sales-na@imopc.com
Web: www.imoautomation.com

IMO South Africa (Pty) Ltd

Unit 2 Trio Park
Prime Park, Printers Way
Cape Town 7441
South Africa

Tel: 021 551 1787

Email: info@imopc.co.za
Web: www.imopc.co.za

IMO Pacific Pty Ltd

Unit 9, Dillington Pass
Landsdale
Perth WA 6065
Australia

Tel: 1300 34 21 31

Email: sales@imopacific.com.au
Web: www.imopacific.com.au



Connect with us and follow
IMO Precision Controls for the
latest news, views and reviews



Errors and omissions excepted. Subject to change without notice. Information correct at time of print.